

METEBOX®

Buatların Genel Özellikleri

General Characteristics of the Thermoplastic Enclosures



Hava Şartlarına Dayanıklı (-40°C / +60°C)
Yağmur Sızdırmaz (IP dereceleri yüksek)
Isıya Dayanıklı
Darbelere Dirençli
Paslanmaz Çelik ve Düşmeyen Vidalar
Kapak Contaları Uzun Ömürlü Poliüretan Conta
Akkor Flaman Deneyi 650°C'e dayanıklı (V2) (HFR).

*Durable against all weather conditions (-40°C / +60°C)
Protected against water penetration (High IP degrees)
Durable against heat and shocks
Stainless steel (Inox) & Captive screws
Long life polyurethane seals used on covers
Endures 650° C glow wire test (V2) (HFR).*



Montaj Kolaylığı
Montaj Sırasında Kutu İçinde Geniş Alan
Esnek Kırılmaz Hammadde (ABS, PS).

*Wide area inside the enclosure
Flexible, durable raw material (ABS, PS).*



Kablo Bağı Kullanma İmkânı
Possibility of using cable ties

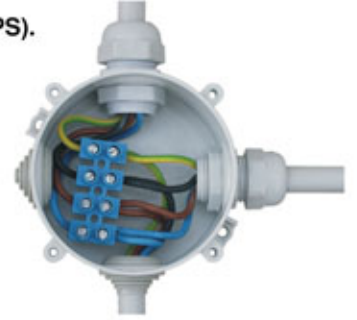

Buat İcini Delmeden IP Derecesini Yükselten Sağlam Montaj Ayakları
Durable fixing devices which increase IP degree



Geniş İç Hacim, Montaj Kolaylığı
Big interior space makes connections easier

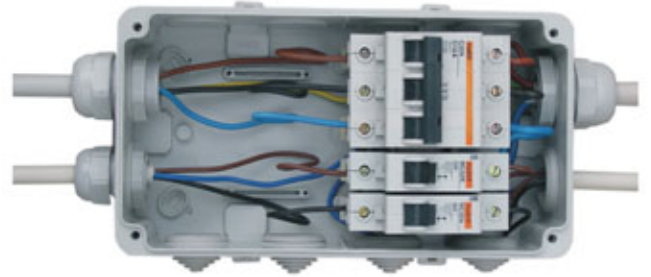

Kademeli Rakorlar

Koruma Sınıfı IP 55
Kablo Girişlerine Tam Olarak Oturur
Kablo Tutma Mukavemeti Yüksek, Elastik
Hava Şartlarından ve Isıdan Etkilenmeyen,
Zamanla Kırılgan Hal Almayan Hammadde

Cable Glands

IP degree 55
Fits tight through cable entries
Flexible raw material causes high ability of surrounding the cable
Long life raw material resistant to different weather conditions



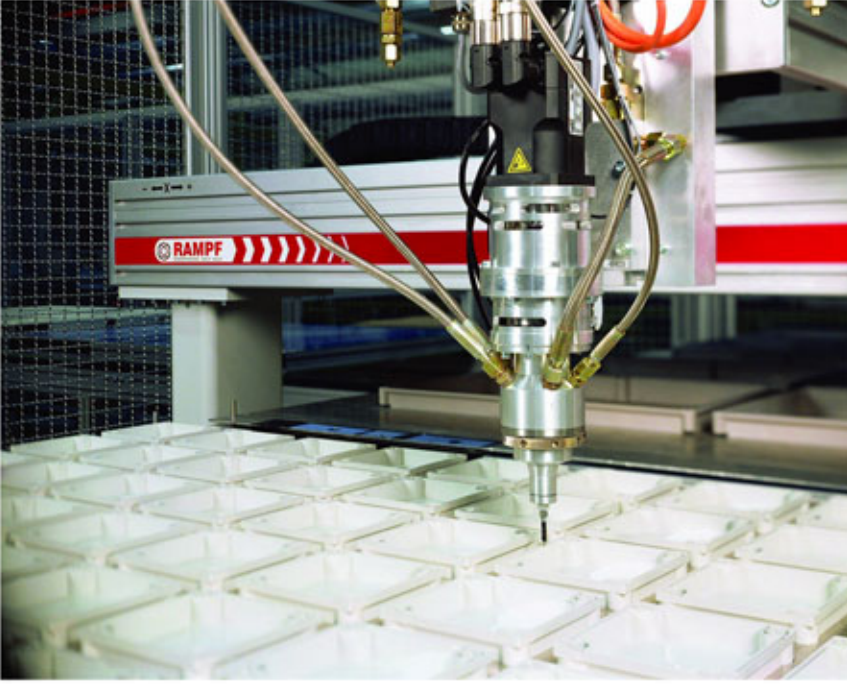

Tüm buat ve kombinasyon gruplarımız IP66 / IP67 sızdırmazlık derecesini sağlamakta olup, teknolojinin bu konudaki en üst düzeyi olan **Sıvı Contalama Tekniği** kullanılarak contalanmaktadır. Tamamen CNC kontrollü contalama makinasında gerçekleştirilen bu süreçte kanal içine dökülen Poliüretan malzeme kimyasal reaksiyon ile kabarak kanalı doldurmakta ve ek yeri oluşturmadan sızdırmazlığı sağlamaktadır.

Bu sayede IP67'ye varan koruma sınıfı her seferinde aynı kalite şartlarında sağlanmış olmaktadır.

*All of our enclosure range can reach up to IP67 ingress protection degree due to the newest technique for gasketing which is known as **Formed in Place Foam Gasketing**. The PU material is poured into the groove and goes into chemical reaction with air and fills the groove completely with no joints.*

Ingress protection degree up to IP67 can be reached in every single item with the same quality level.

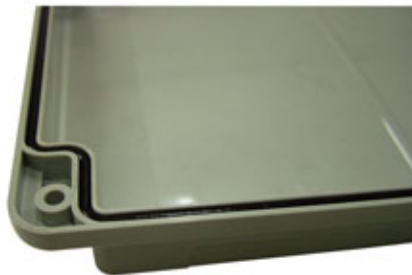
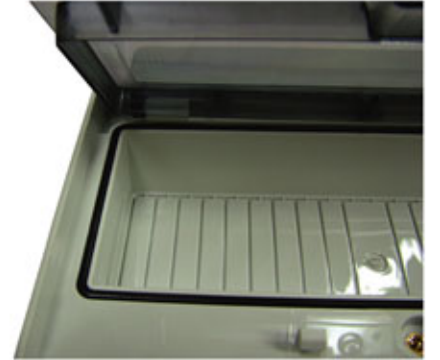

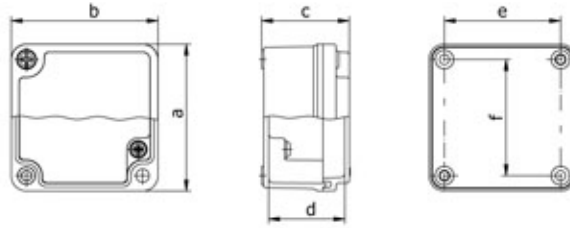

IP 67

a	b	c	d	e	f
65	65	40	34.8	53	53

402502
ALÜMİNYUM BUAT (65 x 65 x 40 mm) Aluminium Enclosure

Amb. /Adet
Packing/Pcs. 216

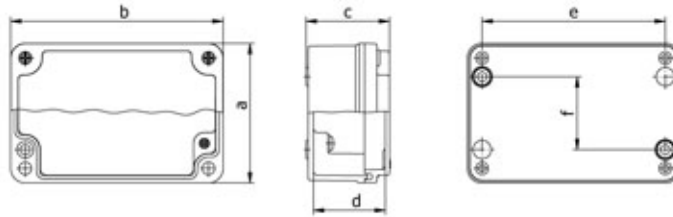

IP 67

a	b	c	d	e	f
65	100	40	34.5	88	35

402503
ALÜMİNYUM BUAT (65 x 100 x 40 mm) Aluminium Enclosure

Amb. /Adet
Packing/Pcs. 120

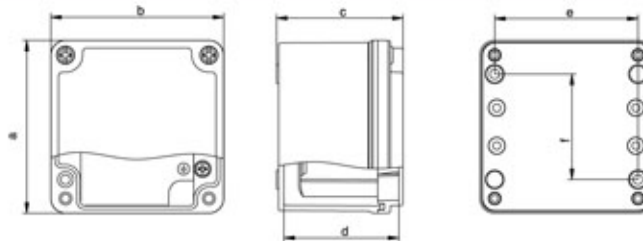

IP 67

a	b	c	d	e	f
80	80	60	54.5	68	50

402504
ALÜMİNYUM BUAT (80 x 80 x 60 mm) Aluminium Enclosure

Amb. /Adet
Packing/Pcs. 100

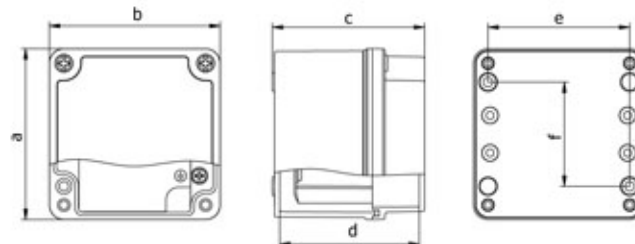

IP 67

a	b	c	d	e	f
80	80	73	67	68	50

402554
ALÜMİNYUM BUAT (80 x 80 x 73 mm) Aluminium Enclosure

Amb. /Adet
Packing/Pcs. 80

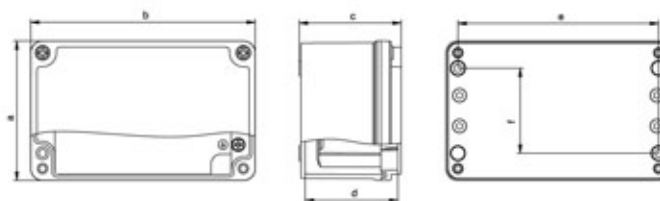
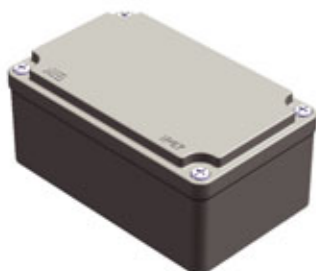

IP 67

a	b	c	d	e	f
80	130	60	54.5	118	50

402505
ALÜMİNYUM BUAT (80 x 130 x 60 mm) Aluminium Enclosure

Amb. /Adet
Packing/Pcs. 65

IP 67

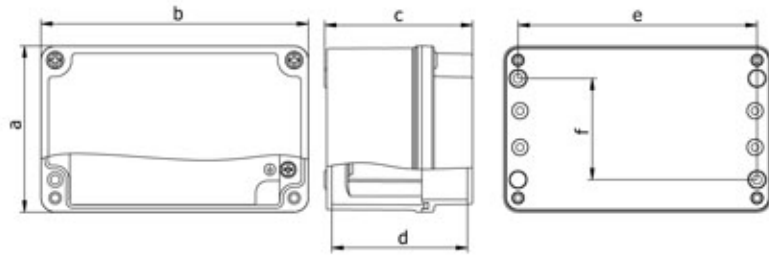
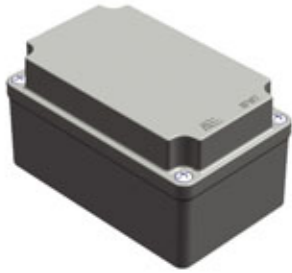

a	b	c	d	e	f
80	130	73	67	118	50

402555

ALÜMİNYUM BUAT (80 x 130 x 73 mm) Aluminium Enclosure

Amb. /Adet
Packing/Pcs. **45**

IP 67

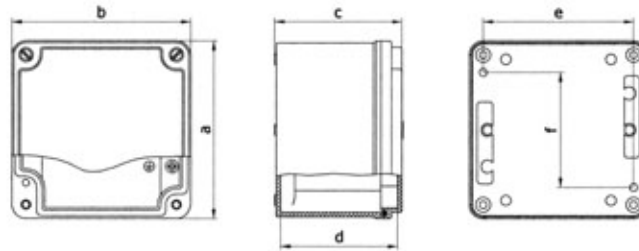

a	b	c	d	e	f
100	100	73	67	86	66

402506

ALÜMİNYUM BUAT (100 x 100 x 73 mm) Aluminium Enclosure

Amb. /Adet
Packing/Pcs. **50**

IP 67

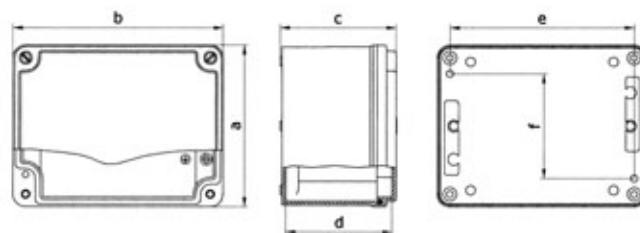

a	b	c	d	e	f
100	130	73	67	116	66

402508

ALÜMİNYUM BUAT (100 x 130 x 73 mm) Aluminium Enclosure

Amb. /Adet
Packing/Pcs. **40**

IP 67

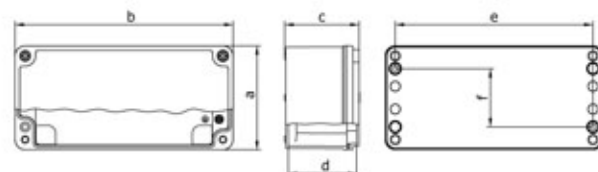

a	b	c	d	e	f
80	170	73	67	156	46

402510

ALÜMİNYUM BUAT (80 x 170 x 73 mm) Aluminium Enclosure

Amb. /Adet
Packing/Pcs. **40**

IP 67

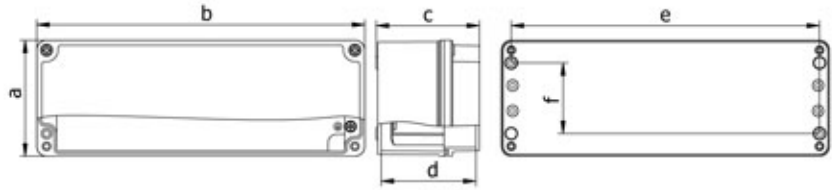
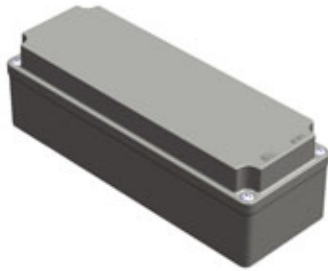

a	b	c	d	e	f
80	230	73	67	218	50

402509

ALÜMİNYUM BUAT (80 x 230 x 73mm) Aluminium Enclosure

Amb. /Adet
Packing/Pcs. **26**

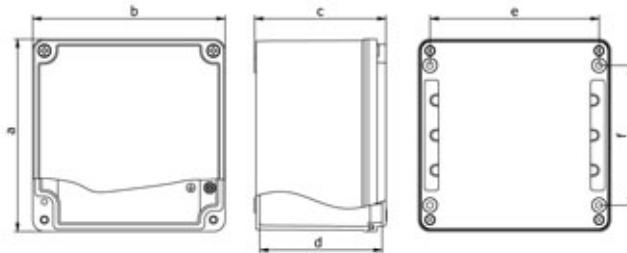

a	b	c	d	e	f
130	130	90	84	116	96

402511

ALÜMİNYUM BUAT (130 x 130 x 90 mm) Aluminium Enclosure

Amb. /Adet
Packing/Pcs. **30**

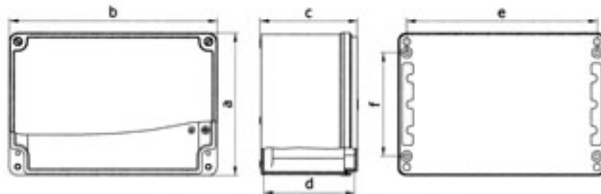

a	b	c	d	e	f
130	190	90	84	176	96

402512

ALÜMİNYUM BUAT (130 x 190 x 90 mm) Aluminium Enclosure

Amb. /Adet
Packing/Pcs. **15**

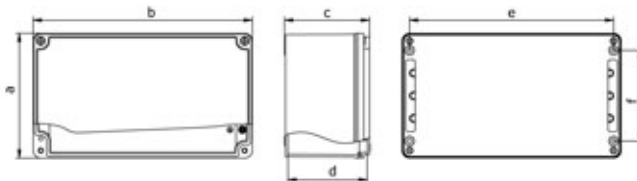

a	b	c	d	e	f
130	230	90	84	216	96

402514

ALÜMİNYUM BUAT (130 x 230 x 90 mm) Aluminium Enclosure

Amb. /Adet
Packing/Pcs. **14**

IP 67

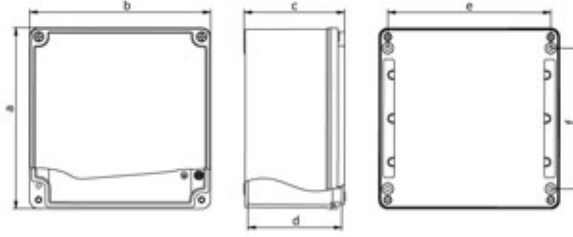
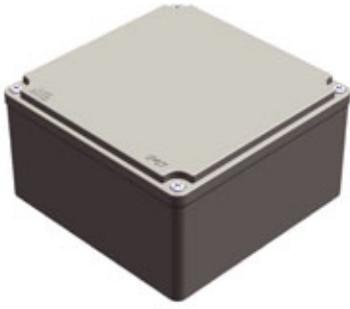

a	b	c	d	e	f
160	160	90	84	146	126

402516

ALÜMİNYUM BUAT (160 X 160 X 90 mm) Aluminium Enclosure

Amb. /Adet
Packing/Pcs. 20

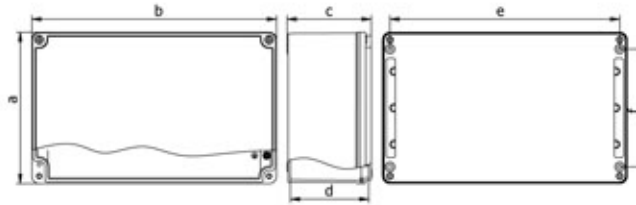
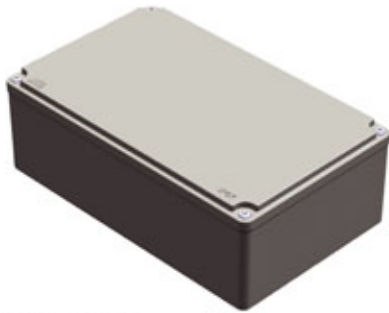

a	b	c	d	e	f
160	260	90	84	246	126

402517

402517H MENTEŞELİ (WITH HINGE)

ALÜMİNYUM BUAT (160 x 260 x 90 mm) Aluminium Enclosure

IP 67

Amb. /Adet
Packing/Pcs. 12

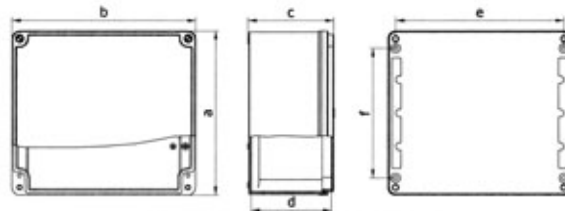

a	b	c	d	e	f
170	190	90	84	176	136

402518

ALÜMİNYUM BUAT (170 x 190 x 90 mm) Aluminium Enclosure

IP 67

Amb. /Adet
Packing/Pcs. 12

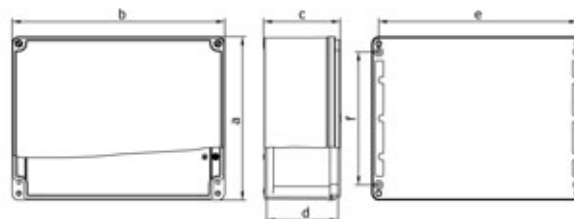

a	b	c	d	e	f
190	250	90	84	236	156

402520

402520H MENTEŞELİ (WITH HINGE)

ALÜMİNYUM BUAT (190 x 250 x 90 mm) Aluminium Enclosure

IP 67

Amb. /Adet
Packing/Pcs. 8

IP 67

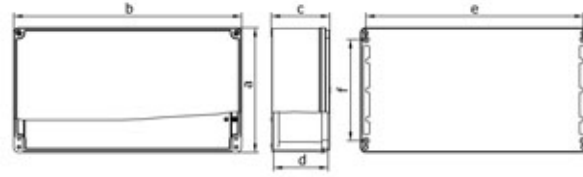
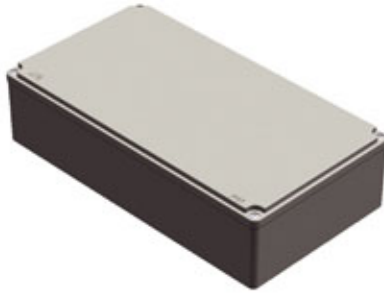

a	b	c	d	e	f
190	350	90	84	336	156

402522

402522H MENTEŞELİ (WITH HINGE)

ALÜMİNYUM BUAT (190 x 350 x 90 mm) Aluminium Enclosure

Amb. /Adet
Packing/Pcs. 6

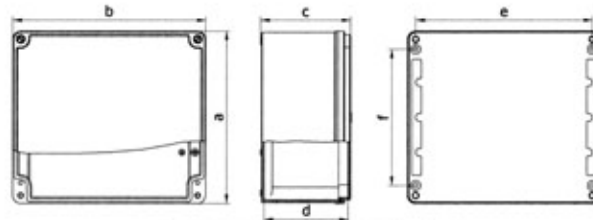

a	b	c	d	e	f
250	250	110	103	230	230

402524

402524H MENTEŞELİ (WITH HINGE)

ALÜMİNYUM BUAT (250 X 250 X 110 mm) Aluminium Enclosure

Amb. /Adet
Packing/Pcs. 4

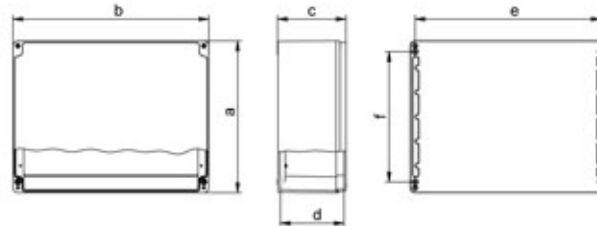
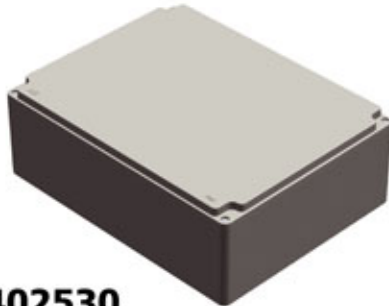

a	b	c	d	e	f
310	400	140	130	380	266

402530

402530H MENTEŞELİ (WITH HINGE)

ALÜMİNYUM BUAT (310 X 400 X 140 mm) Aluminium Enclosure

Amb. /Adet
Packing/Pcs. 3



29980
MENTEŞE
(HINGE)



29981
MENTEŞE
(HINGE)



* Bu ürünlerdeki menteşe kullanımı için danışınız
(Please contact us for the usage of the hinge for these parts)

29980	29981
402517	402524*
402520*	402530
402522*	

NOT: 29980 ve 29981 kodlu menteşeler tabloda belirtilen ürünler için kullanılmaktadır.
NOTE: The hinges having part numbers 29980 and 29981 are to be used for aluminium enclosures mentioned in the list.

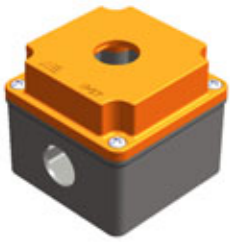
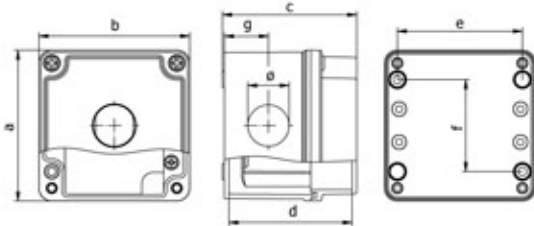

402600
(80 x 80 x 73 mm)

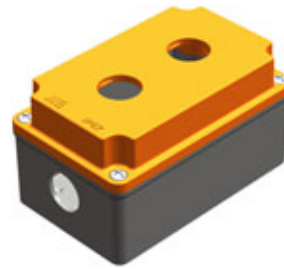
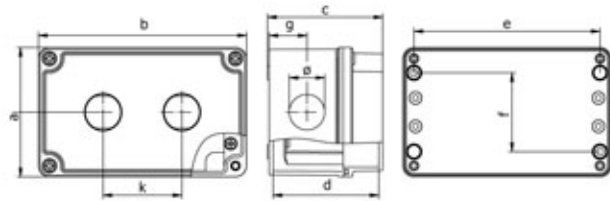
a	b	c	d	e	f	g	h
80	80	73	67	68	50	24	22.5

 Amb. /Adet
Packing/Pcs. 80

402610
(80 x 130 x 73 mm)

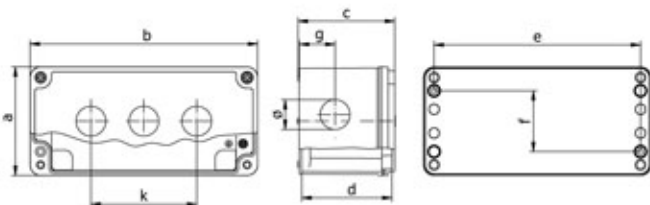
a	b	c	d	e	f	g	k	h
80	130	73	67	118	50	27	50	22.5

 Amb. /Adet
Packing/Pcs. 52

402620
(80 x 170 x 73 mm)

a	b	c	d	e	f	g	k	h
80	170	73	67	156	46	30	80	22.5

 Amb. /Adet
Packing/Pcs. 32

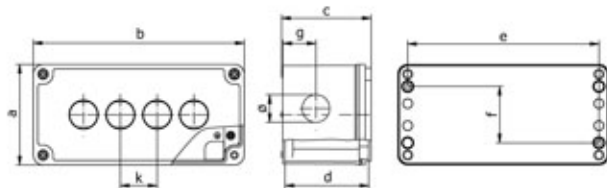
402621
(80 x 170 x 73 mm)

a	b	c	d	e	f	g	k	h
80	170	73	67	156	46	30	30	22.5

 Amb. /Adet
Packing/Pcs. 32

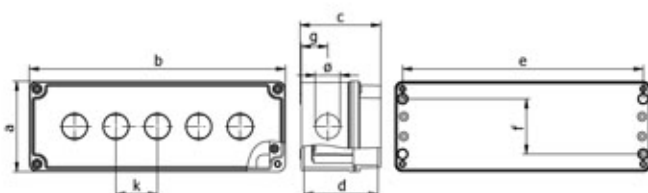
402630
(80 x 230 x 73 mm)

a	b	c	d	e	f	g	k	h
80	230	73	67	218	50	27	37.5	22.5

 Amb. /Adet
Packing/Pcs. 30

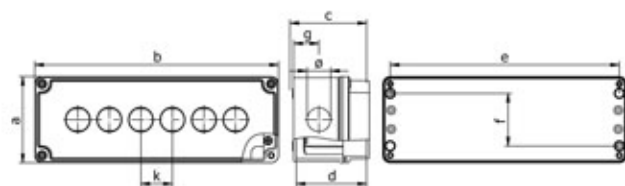
402631
(80 x 230 x 73 mm)

a	b	c	d	e	f	g	k	h
80	230	73	67	218	50	27	30	22.5

 Amb. /Adet
Packing/Pcs. 30

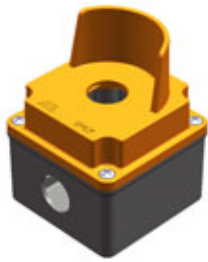

402605
(80 x 80 x 73 mm)

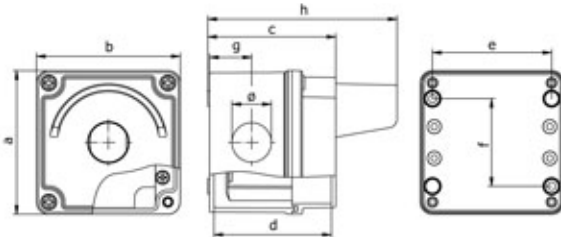

a	b	c	d	e	f	g	h	ø
80	80	73	67	68	50	24	108	22.5

Amb. /Adet
Packing/Pcs. 60



402615
(80 x 130 x 73 mm)

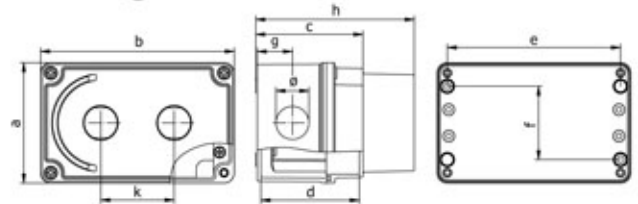

a	b	c	d	e	f	g	h	k	ø
80	130	73	67	118	50	27	108	50	22.5

Amb. /Adet
Packing/Pcs. 48



402625
(80 x 170 x 73 mm)

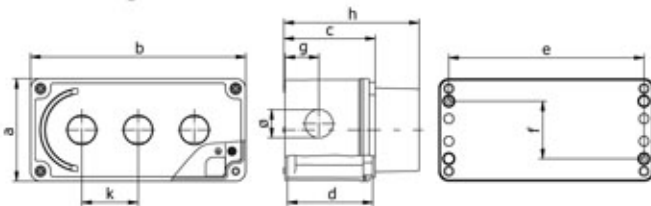

a	b	c	d	e	f	g	h	k	ø
80	170	73	67	156	46	30	108	45	22.5

Amb. /Adet
Packing/Pcs. 30



402626
(80 x 170 x 73 mm)

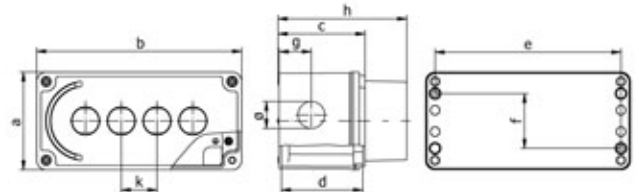

a	b	c	d	e	f	g	h	k	ø
80	170	73	67	156	46	30	108	30	22.5

Amb. /Adet
Packing/Pcs. 30

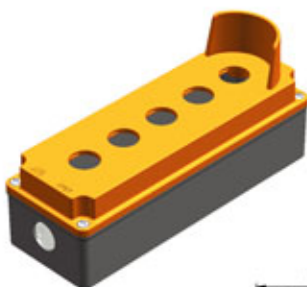

402635
(80 x 230 x 73 mm)

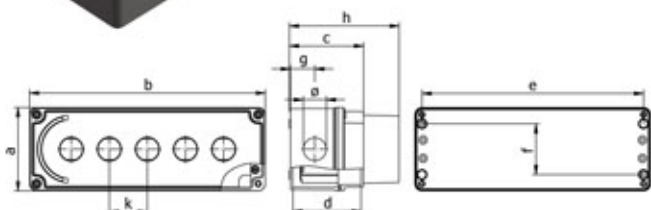

a	b	c	d	e	f	g	h	k	ø
80	230	73	67	218	50	27	108	37.5	22.5

Amb. /Adet
Packing/Pcs. 25



402636
(80 x 230 x 73 mm)

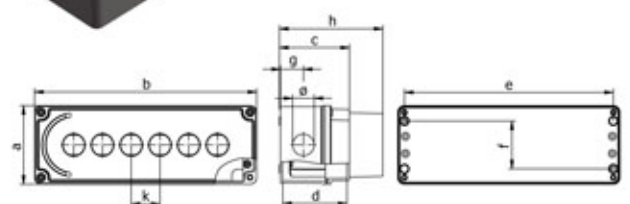

a	b	c	d	e	f	g	h	k	ø
80	230	73	67	218	50	27	108	37.5	22.5

Amb. /Adet
Packing/Pcs. 25

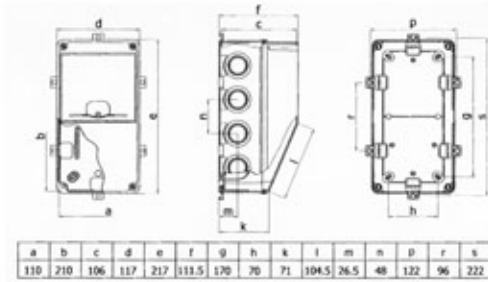
KOMBİNASYON KUTUSU (110 x 210 x 106 mm) Combination Box

a	b	c	d	e	f	g	h	k	i	m	n	p	r	s
110	210	106	117	217	113.5	170	70	71	104.5	26.5	48	122	96	222

 Amb. /Adet
 Packing/Pcs. **24**

Parça No. / Part No.	Malzeme Material	Conta Seal	Rakor girişi / Gland entry		Renk / Color	IP
			Kısa Kenar Short Edge	Uzun Kenar Long Edge		
402025-05	ABS	+	+	+	Gri / Gray (Ral 7035)	66
402025-05ce	PS	+	+	+	Gri / Gray (Ral 7038)	66
402025-02	ABS HF V2	+	+	+	Krem / Ivory (Ral 9016)	66
40202501-05	ABS	+	-	-	Gri / Gray (Ral 7035)	66
40202501-05ce	PS	+	-	-	Gri / Gray (Ral 7038)	66
40202501-02	ABS HF V2	+	-	-	Krem / Ivory (Ral 9016)	66
40202502-05	ABS	+	+	-	Gri / Gray (Ral 7035)	66
40202502-05ce	PS	+	+	-	Gri / Gray (Ral 7038)	66
40202502-02	ABS HF V2	+	+	-	Krem / Ivory (Ral 9016)	66
40202503-05	ABS	+	-	+	Gri / Gray (Ral 7035)	66
40202503-05ce	PS	+	-	+	Gri / Gray (Ral 7038)	66
40202503-02	ABS HF V2	+	-	+	Krem / Ivory (Ral 9016)	66
402025-05e	PS	-	+	+	Gri / Gray (Ral 7038)	54
40202501-05e	PS	-	-	-	Gri / Gray (Ral 7038)	54
40202502-05e	PS	-	+	-	Gri / Gray (Ral 7038)	54
40202503-05e	PS	-	-	+	Gri / Gray (Ral 7038)	54

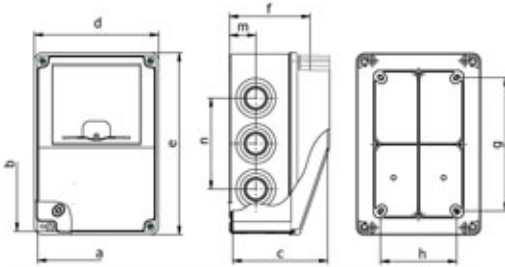
KOMBİNASYON KUTUSU (140 x 210 x 114 mm) Combination Box

a	b	c	d	e	f	g	h	m	n
140	210	114	149	218	96.5	160	91	31.5	109

 Amb. /Adet
 Packing/Pcs. **20**

Parça No. / Part No.	Malzeme Material	Conta Seal	Rakor girişi / Gland entry		Renk / Color	IP
			Kısa Kenar Short Edge	Uzun Kenar Long Edge		
402046-05	ABS	+	+	+	Gri / Gray (Ral 7035)	66
402046-05ce	PS	+	+	+	Gri / Gray (Ral 7038)	66
402046-02	ABS HF V2	+	+	+	Krem / Ivory (Ral 9016)	66
40204601-05	ABS	+	-	-	Gri / Gray (Ral 7035)	66
40204601-05ce	PS	+	-	-	Gri / Gray (Ral 7038)	66
40204601-02	ABS HF V2	+	-	-	Krem / Ivory (Ral 9016)	66
40204602-05	ABS	+	+	-	Gri / Gray (Ral 7035)	66
40204602-05ce	PS	+	+	-	Gri / Gray (Ral 7038)	66
40204602-02	ABS HF V2	+	+	-	Krem / Ivory (Ral 9016)	66
40204603-05	ABS	+	-	+	Gri / Gray (Ral 7035)	66
40204603-05ce	PS	+	-	+	Gri / Gray (Ral 7038)	66
40204603-02	ABS HF V2	+	-	+	Krem / Ivory (Ral 9016)	66
402046-05e	PS	-	+	+	Gri / Gray (Ral 7038)	54
40204601-05e	PS	-	-	-	Gri / Gray (Ral 7038)	54
40204602-05e	PS	-	+	-	Gri / Gray (Ral 7038)	54
40204603-05e	PS	-	-	+	Gri / Gray (Ral 7038)	54

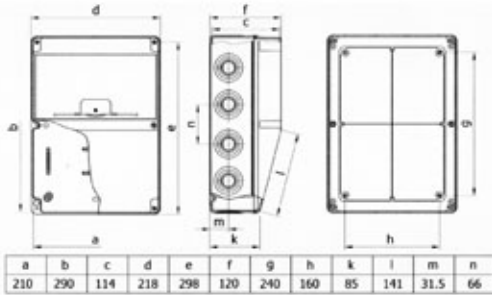
KOMBİNASYON KUTUSU (210 x 290 x 114 mm) Combination Box

Parça No. / Part No.	Malzeme Material	Conta Seal	Rakor girişi / Gland entry		Renk / Color	IP
			Kısa Kenar Short Edge	Uzun Kenar Long Edge		
402035-05	ABS	+	+	+	Gri / Gray (Ral 7035)	66
402035-05ce	PS	+	+	+	Gri / Gray (Ral 7038)	66
402035-02	ABS HF V2	+	+	+	Krem / Ivory (Ral 9016)	66
40203501-05	ABS	+	-	-	Gri / Gray (Ral 7035)	66
40203501-05ce	PS	+	-	-	Gri / Gray (Ral 7038)	66
40203501-02	ABS HF V2	+	-	-	Krem / Ivory (Ral 9016)	66
40203502-05	ABS	+	+	-	Gri / Gray (Ral 7035)	66
40203502-05ce	PS	+	+	-	Gri / Gray (Ral 7038)	66
40203502-02	ABS HF V2	+	+	-	Krem / Ivory (Ral 9016)	66
40203503-05	ABS	+	-	+	Gri / Gray (Ral 7035)	66
40203503-05ce	PS	+	-	+	Gri / Gray (Ral 7038)	66
40203503-02	ABS HF V2	+	-	+	Krem / Ivory (Ral 9016)	66
402035-05e	PS	-	+	+	Gri / Gray (Ral 7038)	54
40203501-05e	PS	-	-	-	Gri / Gray (Ral 7038)	54
40203502-05e	PS	-	+	-	Gri / Gray (Ral 7038)	54
40203503-05e	PS	-	-	+	Gri / Gray (Ral 7038)	54

 Amb. /Adet
 Packing/Pcs. 8

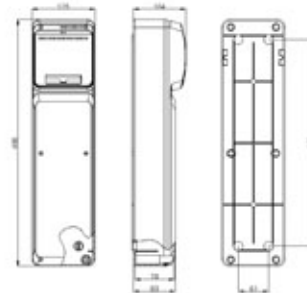
3950
6'LI KOMBİNASYON KUTUSU
(125 x 495 x 110 mm)
 Combination Box With 6 Units
 (Halogen Free, V2) Gri / Gray

IP 65

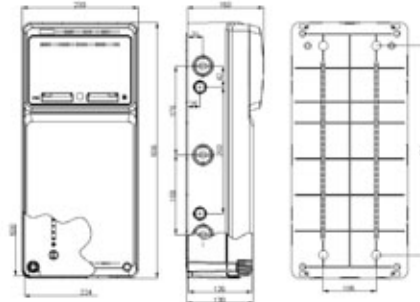
 Amb. /Adet
 Packing/Pcs. 18

3951
8'Lİ KOMBİNASYON KUTUSU
(230 x 506 x 150 mm)
 Combination Box With 8 Units
 (Halogen Free, V2) Gri / Gray

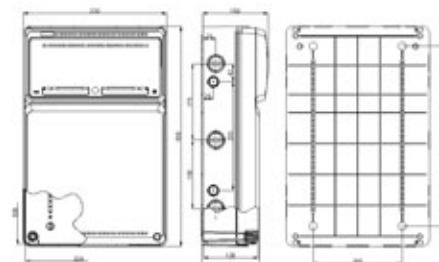
IP 65

 Amb. /Adet
 Packing/Pcs. 6

3952
13'LÜ KOMBİNASYON KUTUSU
(330 x 506 x 150 mm)
 Combination Box With 13 Units
 (Halogen Free, V2) Gri / Gray

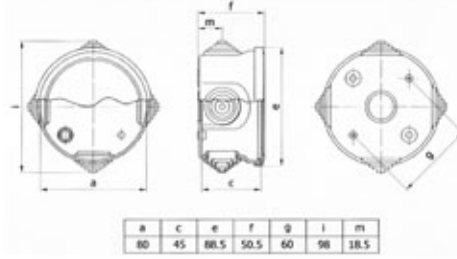
IP 65

 Amb. /Adet
 Packing/Pcs. 4

TERMOPLASTİK BUAT (Geçmeli Kapak) (Ø 80 x 45 mm) Thermoplastic Enclosure (Press Lid)

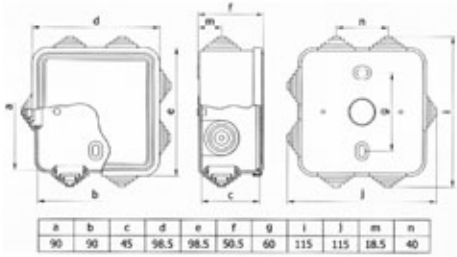
Parça No. / Part No.	Malzeme Material	Renk / Color
402003-05	ABS	Gri / Gray (Ral 7035)
402003-05e	PS	Gri / Gray (Ral 7038)
402003-02	ABS HF V2	Krem / Ivory (Ral 9016)

 Amb./Adet
Packing/Pcs. **200**
TERMOPLASTİK BUAT (Geçmeli Kapak) (90x 90 x 45 mm) Thermoplastic Enclosure (Press Lid)

Parça No. / Part No.	Malzeme Material	Renk / Color
402005-05	ABS	Gri / Gray (Ral 7035)
402005-05e	PS	Gri / Gray (Ral 7038)
402005-02	ABS HF V2	Krem / Ivory (Ral 9016)

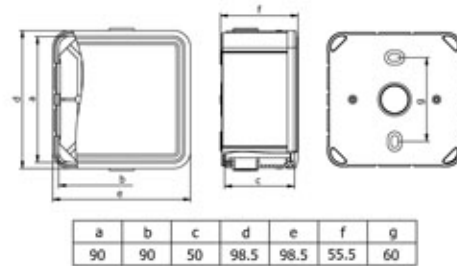
 Amb./Adet
Packing/Pcs. **150**
TERMOPLASTİK BUAT (Geçmeli Kapak) (90 x 90 x 50 mm) Thermoplastic Enclosure (Press Lid)

Parça No. / Part No.	Malzeme Material	Renk / Color
402004-05	ABS	Gri / Gray (Ral 7035)
402004-05e	PS	Gri / Gray (Ral 7038)
402004-02	ABS HF V2	Krem / Ivory (Ral 9016)

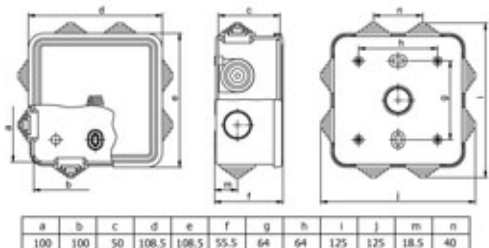
 Amb./Adet
Packing/Pcs. **150**
TERMOPLASTİK BUAT (Geçmeli Kapak) (100 x 100 x 50 mm) Thermoplastic Enclosure (Press Lid)

Parça No. / Part No.	Malzeme Material	Renk / Color
402007-05	ABS	Gri / Gray (Ral 7035)
402007-05e	PS	Gri / Gray (Ral 7038)
402007-02	ABS HF V2	Krem / Ivory (Ral 9016)

 Amb./Adet
Packing/Pcs. **124**

TERMOPLASTİK BUAT (Ø 80 x 45 mm) Thermoplastic Enclosure

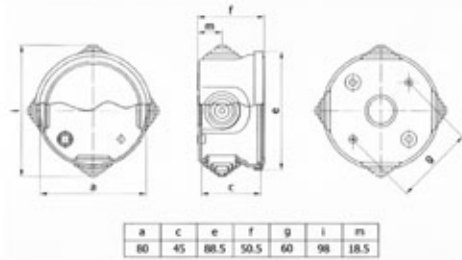

Parça No. / Part No.	Malzeme Material	Conta Seal	Renk / Color	IP
402006-05	ABS	+	Gri / Gray (Ral 7035)	67
402006-05ce	PS	+	Gri / Gray (Ral 7038)	67
402006-02	ABS HF V2	+	Krem / Ivory (Ral 9016)	67
402006-05e	PS	-	Gri / Gray (Ral 7038)	54

Amb. /Adet
Packing/Pcs. 200

TERMOPLASTİK BUAT (110x 110 x 65 mm) Thermoplastic Enclosure

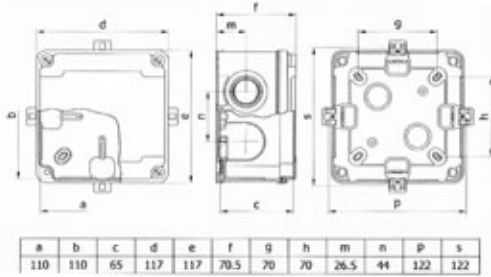

Parça No. / Part No.	Malzeme Material	Conta Seal	Rakor girişi Gland entry	Renk / Color	IP
402010-05	ABS	+	+	Gri / Gray (Ral 7035)	67
402010-05ce	PS	+	+	Gri / Gray (Ral 7038)	67
402010-02	ABS HF V2	+	+	Krem / Ivory (Ral 9016)	67
40201001-05	ABS	+	-	Gri / Gray (Ral 7035)	67
40201001-05ce	PS	+	-	Gri / Gray (Ral 7038)	67
40201001-02	ABS HF V2	+	-	Krem / Ivory (Ral 9016)	67
402010-05e	PS	-	+	Gri / Gray (Ral 7038)	54
40201001-05e	PS	-	-	Gri / Gray (Ral 7038)	54

Amb. /Adet
Packing/Pcs. 80

TERMOPLASTİK BUAT (110x 150 x 70 mm) Thermoplastic Enclosure

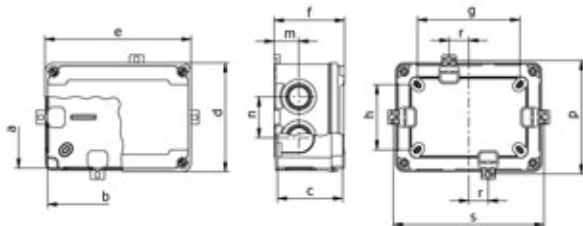

a	b	c	d	e	f	g	h	m	n	p	r	s
110	150	70	117	157	75.5	110	70	26.5	44	122	2	162

Parça No. / Part No.	Malzeme Material	Conta Seal	Rakor girişi Gland entry	Renk / Color	IP
402015-05	ABS	+	+	Gri / Gray (Ral 7035)	67
402015-05ce	PS	+	+	Gri / Gray (Ral 7038)	67
402015-02	ABS HF V2	+	+	Krem / Ivory (Ral 9016)	67
40201501-05	ABS	+	-	Gri / Gray (Ral 7035)	67
40201501-05ce	PS	+	-	Gri / Gray (Ral 7038)	67
40201501-02	ABS HF V2	+	-	Krem / Ivory (Ral 9016)	67
402015-05e	PS	-	+	Gri / Gray (Ral 7038)	54
40201501-05e	PS	-	-	Gri / Gray (Ral 7038)	54

Amb. /Adet
Packing/Pcs. 54

TERMOPLASTİK BUAT (110x 210 x 70 mm) Thermoplastic Enclosure

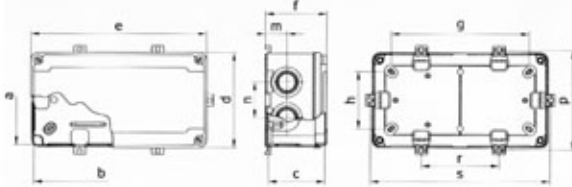

a	b	c	d	e	f	g	h	m	n	p	r	s
110	210	70	117	217	75.5	170	70	26.5	44	122	96	222

Parça No. / Part No.	Malzeme Material	Conta Seal	Rakor girişi Gland entry	Renk / Color	IP
402020-05	ABS	+	+	Gri / Gray (Ral 7035)	67
402020-05ce	PS	+	+	Gri / Gray (Ral 7038)	67
402020-02	HF, V2	+	+	Krem / Ivory (Ral 9016)	67
40202001-05	ABS	+	-	Gri / Gray (Ral 7035)	67
40202001-05ce	PS	+	-	Gri / Gray (Ral 7038)	67
40202001-02	HF, V2	+	-	Krem / Ivory (Ral 9016)	67
402020-05e	PS	-	+	Gri / Gray (Ral 7038)	54
40202001-05e	PS	-	-	Gri / Gray (Ral 7038)	54

Amb. /Adet
Packing/Pcs. **36**

TERMOPLASTİK BUAT (140x 210 x 90 mm) Thermoplastic Enclosure

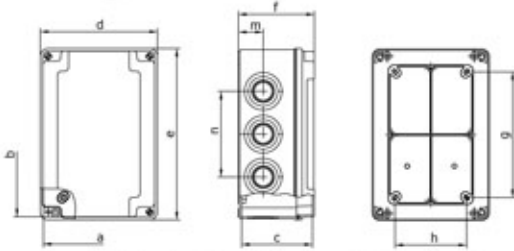

a	b	c	d	e	f	g	h	m	n
140	210	90	149	218	96.5	160	91	31.5	109

Parça No. / Part No.	Malzeme Material	Conta Seal	Rakor girişi Gland entry	Renk / Color	IP
402040-05	ABS	+	+	Gri / Gray (Ral 7035)	67
402040-05ce	PS	+	+	Gri / Gray (Ral 7038)	67
402040-02	HF, V2	+	+	Krem / Ivory (Ral 9016)	67
40204001-05	ABS	+	-	Gri / Gray (Ral 7035)	67
40204001-05ce	PS	+	-	Gri / Gray (Ral 7038)	67
40204001-02	HF, V2	+	-	Krem / Ivory (Ral 9016)	67
402040-05e	PS	-	+	Gri / Gray (Ral 7038)	54
40204001-05e	PS	-	-	Gri / Gray (Ral 7038)	54

Amb. /Adet
Packing/Pcs. **25**

TERMOPLASTİK BUAT (210x 210 x 90 mm) Thermoplastic Enclosure

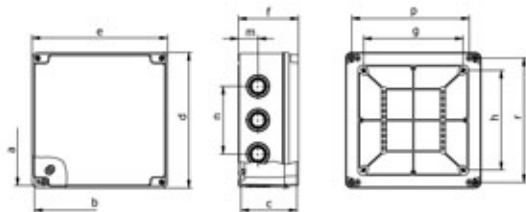
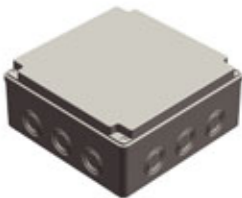

a	b	c	d	e	f	g	h	m	n	p	r
210	210	90	218	218	96.5	160	160	31.5	109	180	200

Parça No. / Part No.	Malzeme Material	Conta Seal	Rakor girişi Gland entry	Renk / Color	IP
402050-05	ABS	+	+	Gri / Gray (Ral 7035)	67
402050-05ce	PS	+	+	Gri / Gray (Ral 7038)	67
402050-02	HF, V2	+	+	Krem / Ivory (Ral 9016)	67
40205001-05	ABS	+	-	Gri / Gray (Ral 7035)	67
40205001-05ce	PS	+	-	Gri / Gray (Ral 7038)	67
40205001-02	HF, V2	+	-	Krem / Ivory (Ral 9016)	67
402050-05e	PS	-	+	Gri / Gray (Ral 7038)	54
40205001-05e	PS	-	-	Gri / Gray (Ral 7038)	54

Amb. /Adet
Packing/Pcs. **12**

TERMOPLASTİK BUAT (190 x 240 x 90 mm) Thermoplastic Enclosure

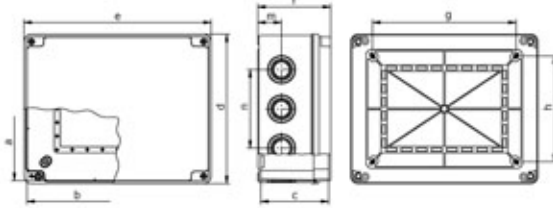
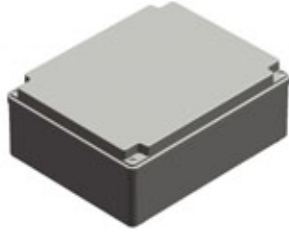

a	b	c	d	e	f	g	h	m	n
190	240	90	198	248	96.5	190	140	31.5	104

Parça No. / Part No.	Malzeme Material	Conta Seal	Rakor girişi Gland entry	Renk / Color	IP
402080-05	ABS	+	+	Gri / Gray (Ral 7035)	67
402080-05ce	PS	+	+	Gri / Gray (Ral 7038)	67
402080-02	ABS HF V2	+	+	Krem / Ivory (Ral 9016)	67
40208001-05	ABS	+	-	Gri / Gray (Ral 7035)	67
40208001-05ce	PS	+	-	Gri / Gray (Ral 7038)	67
40208001-02	ABS HF V2	+	-	Krem / Ivory (Ral 9016)	67
402080-05e	PS	-	+	Gri / Gray (Ral 7038)	54
40208001-05e	PS	-	-	Gri / Gray (Ral 7038)	54

Amb. /Adet
Packing/Pcs. 18

TERMOPLASTİK BUAT (210 x 290 x 90 mm) Thermoplastic Enclosure

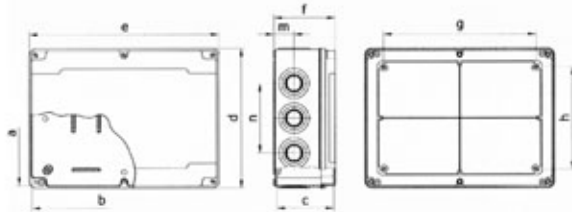

a	b	c	d	e	f	g	h	m	n
210	290	90	218	298	96.5	240	160	31.5	109

Parça No. / Part No.	Malzeme Material	Conta Seal	Rakor girişi Gland entry	Renk / Color	IP
402030-05	ABS	+	+	Gri / Gray (Ral 7035)	67
402030-05ce	PS	+	+	Gri / Gray (Ral 7038)	67
402030-02	ABS HF V2	+	+	Krem / Ivory (Ral 9016)	67
40203001-05	ABS	+	-	Gri / Gray (Ral 7035)	67
40203001-05ce	PS	+	-	Gri / Gray (Ral 7038)	67
40203001-02	ABS HF V2	+	-	Krem / Ivory (Ral 9016)	67
402030-05e	PS	-	+	Gri / Gray (Ral 7038)	54
40203001-05e	PS	-	-	Gri / Gray (Ral 7038)	54

Amb. /Adet
Packing/Pcs. 10

TERMOPLASTİK BUAT (290 x 290 x 90 mm) Thermoplastic Enclosure

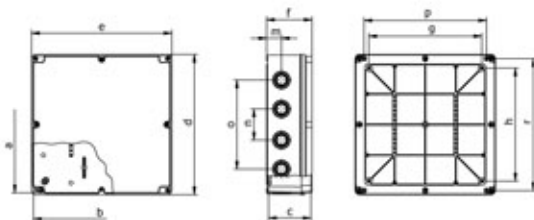
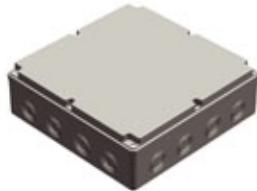

a	b	c	d	e	f	g	h	m	n	o	p	r
290	290	90	298	298	96.5	240	240	31.5	66	189	260	280

Parça No. / Part No.	Malzeme Material	Conta Seal	Rakor girişi Gland entry	Renk / Color	IP
402070-05	ABS	+	+	Gri / Gray (Ral 7035)	67
402070-05ce	PS	+	+	Gri / Gray (Ral 7038)	67
402070-02	ABS HF V2	+	+	Krem / Ivory (Ral 9016)	67
40207001-05	ABS	+	-	Gri / Gray (Ral 7035)	67
40207001-05ce	PS	+	-	Gri / Gray (Ral 7038)	67
40207001-02	ABS HF V2	+	-	Krem / Ivory (Ral 9016)	67
402070-05e	PS	-	+	Gri / Gray (Ral 7038)	54
40207001-05e	PS	-	-	Gri / Gray (Ral 7038)	54

Amb. /Adet
Packing/Pcs. 5



IP 65

3955 (Halogen Free, V2)
Gri / Gray
TERMOPLASTİK BUAT
(330 x 180 x 130 mm)
Thermoplastic Enclosure

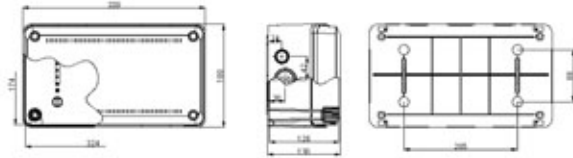

Amb. /Adet Packing/Pcs. 12



IP 65

3956 (Halogen Free, V2)
Gri / Gray
TERMOPLASTİK BUAT
(330 x 330 x 130 mm)
Thermoplastic Enclosure

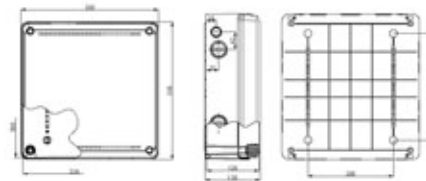

Amb. /Adet Packing/Pcs. 6



3953 (Halogen Free, V2) Gri / Gray
TERMOPLASTİK BUAT (230 x 506 x 130 mm) Thermoplastic Enclosure

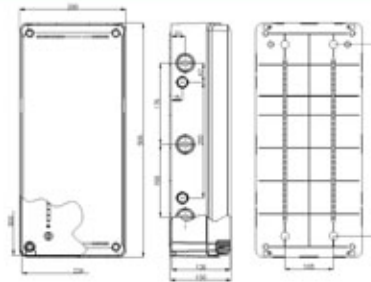

IP 65

Amb. /Adet Packing/Pcs. 6



3954 (Halogen Free, V2) Gri / Gray
TERMOPLASTİK BUAT (330 x 506 x 130 mm) Thermoplastic Enclosure

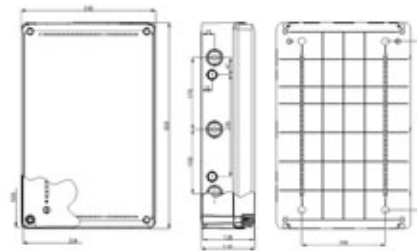

IP 65

Amb. /Adet Packing/Pcs. 4

TERMOPLASTİK BUAT (Derin Kapak) (110 x 110 x 100 mm) Thermoplastic Enclosure (Deep Cover)

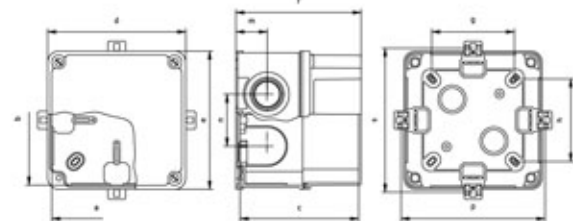

Parça No. / Part No.	Malzeme Material	Conta Seal	Rakor girişi Gland entry	Renk / Color	IP
402012-05	ABS	+	+	Gri / Gray (Ral 7035)	67
402012-05ce	PS	+	+	Gri / Gray (Ral 7038)	67
402012-02	ABS HF V2	+	+	Krem / Ivory (Ral 9016)	67
40201201-05	ABS	+	-	Gri / Gray (Ral 7035)	67
40201201-05ce	PS	+	-	Gri / Gray (Ral 7038)	67
40201201-02	ABS HF V2	+	-	Krem / Ivory (Ral 9016)	67
402012-05e	PS	-	+	Gri / Gray (Ral 7038)	54
40201201-05e	PS	-	-	Gri / Gray (Ral 7038)	54

Amb. /Adet Packing/Pcs. 48

TERMOPLASTİK BUAT (Derin Kapak) (110 x 150 x 120 mm) Thermoplastic Enclosure (Deep Cover)

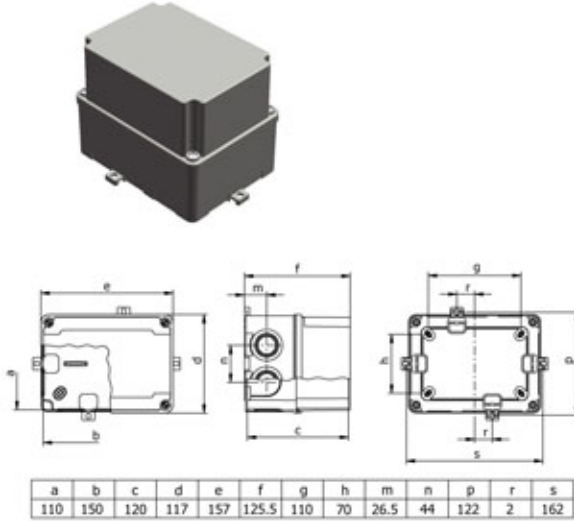

Parça No. / Part No.	Malzeme Material	Conta Seal	Rakor girişi Gland entry	Renk / Color	IP
402016-05	ABS	+	+	Gri / Gray (Ral 7035)	67
402016-05ce	PS	+	+	Gri / Gray (Ral 7038)	67
402016-02	ABS HF V2	+	+	Krem / Ivory (Ral 9016)	67
40201601-05	ABS	+	-	Gri / Gray (Ral 7035)	67
40201601-05ce	PS	+	-	Gri / Gray (Ral 7038)	67
40201601-02	ABS HF V2	+	-	Krem / Ivory (Ral 9016)	67
402016-05e	PS	-	+	Gri / Gray (Ral 7038)	54
40201601-05e	PS	-	-	Gri / Gray (Ral 7038)	54

Amb. /Adet
Packing/Pcs. **36**

TERMOPLASTİK BUAT (Derin Kapak) (110 x 210 x 120 mm) Thermoplastic Enclosure (Deep Cover)

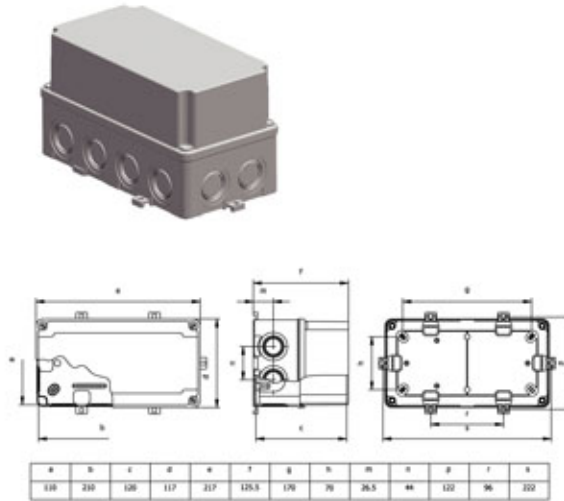

Parça No. / Part No.	Malzeme Material	Conta Seal	Rakor girişi Gland entry	Renk / Color	IP
402022-05	ABS	+	+	Gri / Gray (Ral 7035)	67
402022-05ce	PS	+	+	Gri / Gray (Ral 7038)	67
402022-02	ABS HF V2	+	+	Krem / Ivory (Ral 9016)	67
40202201-05	ABS	+	-	Gri / Gray (Ral 7035)	67
40202201-05ce	PS	+	-	Gri / Gray (Ral 7038)	67
40202201-02	ABS HF V2	+	-	Krem / Ivory (Ral 9016)	67
402022-05e	PS	-	+	Gri / Gray (Ral 7038)	54
40202201-05e	PS	-	-	Gri / Gray (Ral 7038)	54

Amb. /Adet
Packing/Pcs. **24**

TERMOPLASTİK BUAT (Derin Kapak) (140 x 210 x 140 mm) Thermoplastic Enclosure (Deep Cover)

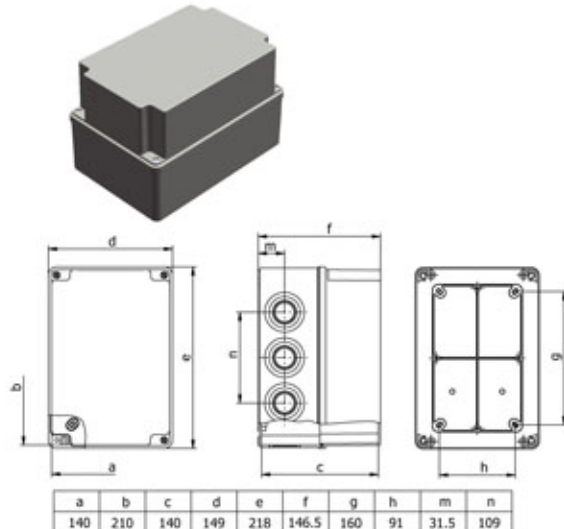

Parça No. / Part No.	Malzeme Material	Conta Seal	Rakor girişi Gland entry	Renk / Color	IP
402042-05	ABS	+	+	Gri / Gray (Ral 7035)	67
402042-05ce	PS	+	+	Gri / Gray (Ral 7038)	67
402042-02	ABS HF V2	+	+	Krem / Ivory (Ral 9016)	67
40204201-05	ABS	+	-	Gri / Gray (Ral 7035)	67
40204201-05ce	PS	+	-	Gri / Gray (Ral 7038)	67
40204201-02	ABS HF V2	+	-	Krem / Ivory (Ral 9016)	67
402042-05e	PS	-	+	Gri / Gray (Ral 7038)	54
40204201-05e	PS	-	-	Gri / Gray (Ral 7038)	54

Amb. /Adet
Packing/Pcs. **15**

TERMOPLASTİK BUAT (Derin Kapak) (210 x 210 x 140 mm) Thermoplastic Enclosure (Deep Cover)

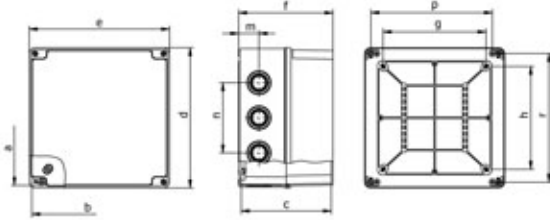

a	b	c	d	e	f	g	h	m	n	p	r
210	210	140	218	218	146.5	160	160	31.5	109	180	200

Parça No. / Part No.	Malzeme Material	Conta Seal	Rakor girişi Gland entry	Renk / Color	IP
402052-05	ABS	+	+	Gri / Gray (Ral 7035)	67
402052-05ce	PS	+	+	Gri / Gray (Ral 7038)	67
402052-02	ABS HF V2	+	+	Krem / Ivory (Ral 9016)	67
40205201-05	ABS	+	-	Gri / Gray (Ral 7035)	67
40205201-05ce	PS	+	-	Gri / Gray (Ral 7038)	67
40205201-02	ABS HF V2	+	-	Krem / Ivory (Ral 9016)	67
402052-05e	PS	-	+	Gri / Gray (Ral 7038)	54
40205201-05e	PS	-	-	Gri / Gray (Ral 7038)	54

Amb. /Adet
Packing/Pcs. **10**

TERMOPLASTİK BUAT (Derin Kapak) (190 x 240 x 160 mm) Thermoplastic Enclosure (Deep Cover)

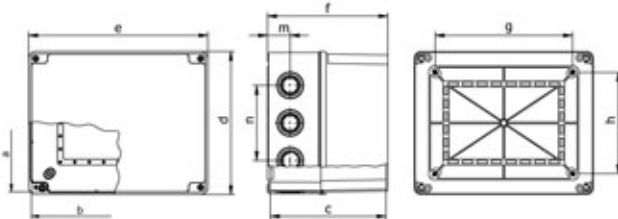
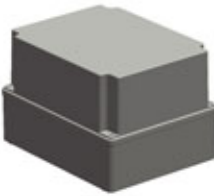

a	b	c	d	e	f	g	h	m	n
190	240	160	198	248	166.5	190	140	31.5	104

Parça No. / Part No.	Malzeme Material	Conta Seal	Rakor girişi Gland entry	Renk / Color	IP
402082-05	ABS	+	+	Gri / Gray (Ral 7035)	67
402082-05ce	PS	+	+	Gri / Gray (Ral 7038)	67
402082-02	ABS HF V2	+	+	Krem / Ivory (Ral 9016)	67
40208201-05	ABS	+	-	Gri / Gray (Ral 7035)	67
40208201-05ce	PS	+	-	Gri / Gray (Ral 7038)	67
40208201-02	ABS HF V2	+	-	Krem / Ivory (Ral 9016)	67
402082-05e	PS	-	+	Gri / Gray (Ral 7038)	54
40208201-05e	PS	-	-	Gri / Gray (Ral 7038)	54

Amb. /Adet
Packing/Pcs. **10**

TERMOPLASTİK BUAT (Derin Kapak) (210 x 290 x 140 mm) Thermoplastic Enclosure (Deep Cover)

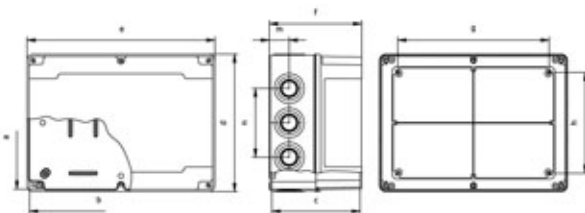
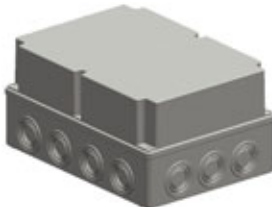

a	b	c	d	e	f	g	h	m	n
210	290	140	218	298	146.5	240	160	31.5	109

Parça No. / Part No.	Malzeme Material	Conta Seal	Rakor girişi Gland entry	Renk / Color	IP
402032-05	ABS	+	+	Gri / Gray (Ral 7035)	67
402032-05ce	PS	+	+	Gri / Gray (Ral 7038)	67
402032-02	ABS HF V2	+	+	Krem / Ivory (Ral 9016)	67
40203201-05	ABS	+	-	Gri / Gray (Ral 7035)	67
40203201-05ce	PS	+	-	Gri / Gray (Ral 7038)	67
40203201-02	ABS HF V2	+	-	Krem / Ivory (Ral 9016)	67
402032-05e	PS	-	+	Gri / Gray (Ral 7038)	54
40203201-05e	PS	-	-	Gri / Gray (Ral 7038)	54

Amb. /Adet
Packing/Pcs. **6**

TERMOPLASTİK BUAT (Derin Kapak) (290 x 290 x 140 mm) Thermoplastic Enclosure (Deep Cover)

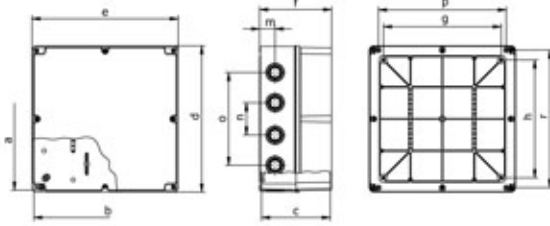
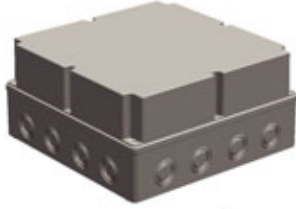

a	b	c	d	e	f	g	h	m	n	o	p	r
290	290	140	298	298	146.5	240	240	31.5	66	189	260	280

Parça No. / Part No.	Malzeme Material	Conta Seal	Rakor girişi Gland entry	Renk / Color	IP
402072-05	ABS	+	+	Gri / Gray (Ral 7035)	67
402072-05ce	PS	+	+	Gri / Gray (Ral 7038)	67
402072-02	ABS HF V2	+	+	Krem / Ivory (Ral 9016)	67
40207201-05	ABS	+	-	Gri / Gray (Ral 7035)	67
40207201-05ce	PS	+	-	Gri / Gray (Ral 7038)	67
40207201-02	ABS HF V2	+	-	Krem / Ivory (Ral 9016)	67
402072-05e	PS	-	+	Gri / Gray (Ral 7038)	54
40207201-05e	PS	-	-	Gri / Gray (Ral 7038)	54

Amb./Adet
Packing/Pcs. **4**

TERMOPLASTİK BUAT (Şeffaf Kapak) (110 x 150 x 70 mm) Thermoplastic Enclosure (Transparent Cover)

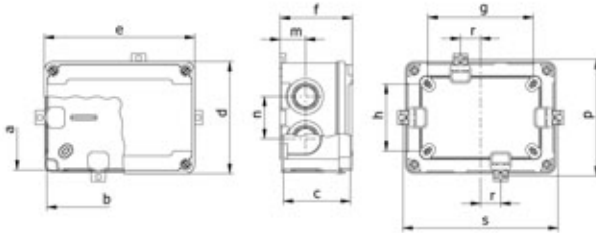

a	b	c	d	e	f	g	h	m	n	p	r	s
110	150	70	117	157	75.5	110	70	26.5	44	122	2	162

Parça No. / Part No.	Malzeme Material	Conta Seal	Rakor girişi Gland entry	Renk / Color	IP
402015-07	ABS	+	+	Gri / Gray (Ral 7035)	67
402015-07ce	PS	+	+	Gri / Gray (Ral 7038)	67
402015-27	ABS HF V2	+	+	Krem / Ivory (Ral 9016)	67
40201501-07	ABS	+	-	Gri / Gray (Ral 7035)	67
40201501-07ce	PS	+	-	Gri / Gray (Ral 7038)	67
40201501-27	ABS HF V2	+	-	Krem / Ivory (Ral 9016)	67
402015-07e	PS	-	+	Gri / Gray (Ral 7038)	54
40201501-07e	PS	-	-	Gri / Gray (Ral 7038)	54

Amb./Adet
Packing/Pcs. **54**

TERMOPLASTİK BUAT (Şeffaf Kapak) (110 x 210 x 70 mm) Thermoplastic Enclosure (Transparent Cover)

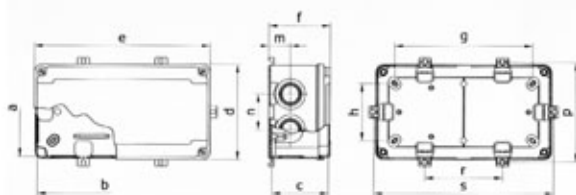

a	b	c	d	e	f	g	h	m	n	p	r	s
110	210	70	117	217	75.5	170	70	26.5	44	122	96	222

Parça No. / Part No.	Malzeme Material	Conta Seal	Rakor girişi Gland entry	Renk / Color	IP
402020-07	ABS	+	+	Gri / Gray (Ral 7035)	67
402020-07ce	PS	+	+	Gri / Gray (Ral 7038)	67
402020-27	ABS HF V2	+	+	Krem / Ivory (Ral 9016)	67
40202001-07	ABS	+	-	Gri / Gray (Ral 7035)	67
40202001-07ce	PS	+	-	Gri / Gray (Ral 7038)	67
40202001-27	ABS HF V2	+	-	Krem / Ivory (Ral 9016)	67
402020-07e	PS	-	+	Gri / Gray (Ral 7038)	54
40202001-07e	PS	-	-	Gri / Gray (Ral 7038)	54

Amb./Adet
Packing/Pcs. **36**

TERMOPLASTİK BUAT (Şeffaf Kapak) (140 x 210 x 90 mm) Thermoplastic Enclosure (Transparent Cover)

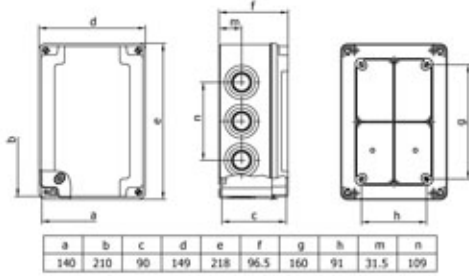

a	b	c	d	e	f	g	h	m	n
140	210	90	149	218	96.5	160	91	31.5	109

Parça No. / Part No.	Malzeme Material	Conta Seal	Rakor girişi Gland entry	Renk / Color	IP
402040-07	ABS	+	+	Gri / Gray (Ral 7035)	67
402040-07ce	PS	+	+	Gri / Gray (Ral 7038)	67
402040-27	ABS HF V2	+	+	Krem / Ivory (Ral 9016)	67
40204001-07	ABS	+	-	Gri / Gray (Ral 7035)	67
40204001-07ce	PS	+	-	Gri / Gray (Ral 7038)	67
40204001-27	ABS HF V2	+	-	Krem / Ivory (Ral 9016)	67
402040-07e	PS	-	+	Gri / Gray (Ral 7038)	54
40204001-07e	PS	-	-	Gri / Gray (Ral 7038)	54

Amb./Adet
Packing/Pcs. **25**

TERMOPLASTİK BUAT (Şeffaf Kapak) (210 x 210 x 90 mm) Thermoplastic Enclosure (Transparent Cover)

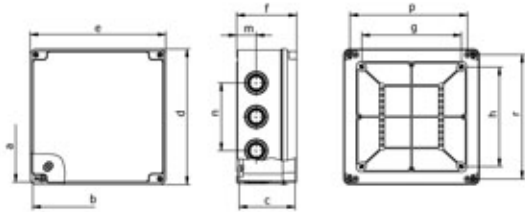

a	b	c	d	e	f	g	h	m	n	p	r
210	210	90	218	218	96.5	160	160	31.5	109	180	200

Parça No. / Part No.	Malzeme Material	Conta Seal	Rakor girişi Gland entry	Renk / Color	IP
402050-07	ABS	+	+	Gri / Gray (Ral 7035)	67
402050-07ce	PS	+	+	Gri / Gray (Ral 7038)	67
402050-27	ABS HF V2	+	+	Krem / Ivory (Ral 9016)	67
40205001-07	ABS	+	-	Gri / Gray (Ral 7035)	67
40205001-07ce	PS	+	-	Gri / Gray (Ral 7038)	67
40205001-27	ABS HF V2	+	-	Krem / Ivory (Ral 9016)	67
402050-07e	PS	-	+	Gri / Gray (Ral 7038)	54
40205001-07e	PS	-	-	Gri / Gray (Ral 7038)	54

Amb./Adet
Packing/Pcs. **12**

TERMOPLASTİK BUAT (Şeffaf Kapak) (190 x 240 x 90 mm) Thermoplastic Enclosure (Transparent Cover)

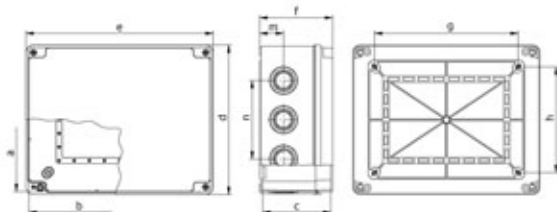
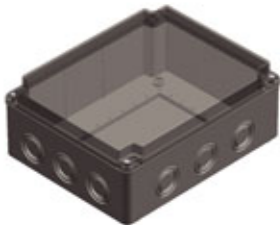

a	b	c	d	e	f	g	h	m	n
190	240	90	198	248	96.5	190	140	31.5	104

Parça No. / Part No.	Malzeme Material	Conta Seal	Rakor girişi Gland entry	Renk / Color	IP
402080-07	ABS	+	+	Gri / Gray (Ral 7035)	67
402080-07ce	PS	+	+	Gri / Gray (Ral 7038)	67
402080-27	ABS HF V2	+	+	Krem / Ivory (Ral 9016)	67
40208001-07	ABS	+	-	Gri / Gray (Ral 7035)	67
40208001-07ce	PS	+	-	Gri / Gray (Ral 7038)	67
40208001-27	ABS HF V2	+	-	Krem / Ivory (Ral 9016)	67
402080-07e	PS	-	+	Gri / Gray (Ral 7038)	54
40208001-07e	PS	-	-	Gri / Gray (Ral 7038)	54

Amb./Adet
Packing/Pcs. **18**

TERMOPLASTİK BUAT (Şeffaf Kapak) (210 x 290 x 90 mm) Thermoplastic Enclosure (Transparent Cover)

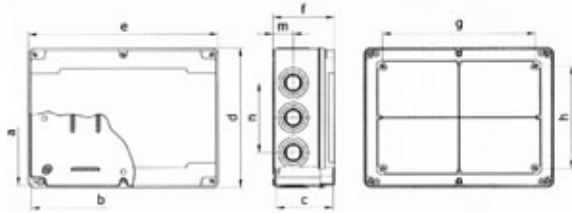

a	b	c	d	e	f	g	h	m	n
210	290	90	218	298	96.5	240	160	31.5	109

Parça No. / Part No.	Malzeme Material	Conta Seal	Rakor girişi Gland entry	Renk / Color	IP
402030-07	ABS	+	+	Gri / Gray (Ral 7035)	67
402030-07ce	PS	+	+	Gri / Gray (Ral 7038)	67
402030-27	ABS HF V2	+	+	Krem / Ivory (Ral 9016)	67
40203001-07	ABS	+	-	Gri / Gray (Ral 7035)	67
40203001-07ce	PS	+	-	Gri / Gray (Ral 7038)	67
40203001-27	ABS HF V2	+	-	Krem / Ivory (Ral 9016)	67
402030-07e	PS	-	+	Gri / Gray (Ral 7038)	54
40203001-07e	PS	-	-	Gri / Gray (Ral 7038)	54

Amb. /Adet
Packing/Pcs. 10

TERMOPLASTİK BUAT (Şeffaf Kapak) (290 x 290 x 90 mm) Thermoplastic Enclosure (Transparent Cover)

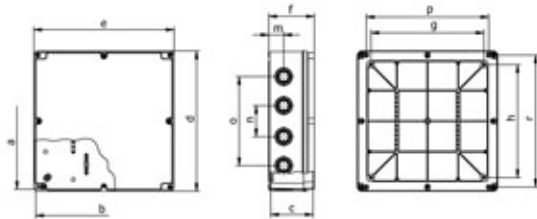

a	b	c	d	e	f	g	h	m	n	o	p	r
290	290	90	298	298	96.5	240	240	31.5	66	189	260	280

Parça No. / Part No.	Malzeme Material	Conta Seal	Rakor girişi Gland entry	Renk / Color	IP
402070-07	ABS	+	+	Gri / Gray (Ral 7035)	67
402070-07ce	PS	+	+	Gri / Gray (Ral 7038)	67
402070-27	ABS HF V2	+	+	Krem / Ivory (Ral 9016)	67
40207001-07	ABS	+	-	Gri / Gray (Ral 7035)	67
40207001-07ce	PS	+	-	Gri / Gray (Ral 7038)	67
40207001-27	ABS HF V2	+	-	Krem / Ivory (Ral 9016)	67
402070-07e	PS	-	+	Gri / Gray (Ral 7038)	54
40207001-07e	PS	-	-	Gri / Gray (Ral 7038)	54

Amb. /Adet
Packing/Pcs. 5

TERMOPLASTİK BUAT (Derin Şeffaf Kapak) (110 x 110 x 100 mm) Thermoplastic Enclosure (Transparent Deep Cover)

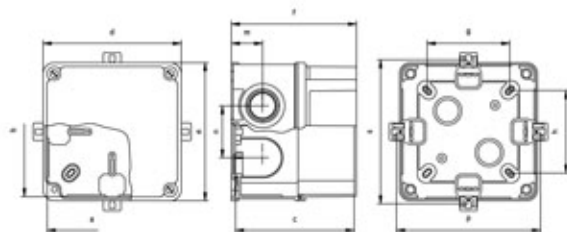

a	b	c	d	e	f	g	h	m	n	o	p	r
110	110	100	117	117	105.5	70	70	26.5	44	110	122	122

Parça No. / Part No.	Malzeme Material	Conta Seal	Rakor girişi Gland entry	Renk / Color	IP
402012-07	ABS	+	+	Gri / Gray (Ral 7035)	67
402012-07ce	PS	+	+	Gri / Gray (Ral 7038)	67
402012-27	ABS HF V2	+	+	Krem / Ivory (Ral 9016)	67
40201201-07	ABS	+	-	Gri / Gray (Ral 7035)	67
40201201-07ce	PS	+	-	Gri / Gray (Ral 7038)	67
40201201-27	ABS HF V2	+	-	Krem / Ivory (Ral 9016)	67
402012-07e	PS	-	+	Gri / Gray (Ral 7038)	54
40201201-07e	PS	-	-	Gri / Gray (Ral 7038)	54

Amb. /Adet
Packing/Pcs. 48

TERMOPLASTİK BUAT (Derin Şeffaf Kapak) (110 x 150 x 120 mm) Thermoplastic Enclosure (Transparent Deep Cover)

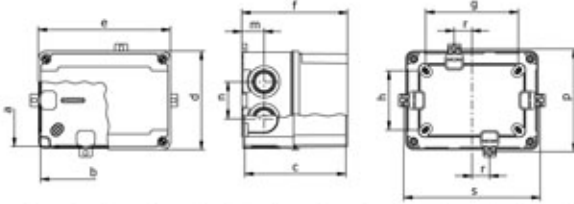

a	b	c	d	e	f	g	h	m	n	p	r	s
110	150	120	117	157	125.5	110	70	26.5	44	122	2	162

Parça No. / Part No.	Malzeme Material	Conta Seal	Rakor girişi Gland entry	Renk / Color	IP
402016-07	ABS	+	+	Gri / Gray (Ral 7035)	67
402016-07ce	PS	+	+	Gri / Gray (Ral 7038)	67
402016-27	ABS HF V2	+	+	Krem / Ivory (Ral 9016)	67
40201601-07	ABS	+	-	Gri / Gray (Ral 7035)	67
40201601-07ce	PS	+	-	Gri / Gray (Ral 7038)	67
40201601-27	ABS HF V2	+	-	Krem / Ivory (Ral 9016)	67
402016-07e	PS	-	+	Gri / Gray (Ral 7038)	54
40201601-07e	PS	-	-	Gri / Gray (Ral 7038)	54

Amb. /Adet
Packing/Pcs. **36**

TERMOPLASTİK BUAT (Derin Şeffaf Kapak) (110 x 210 x 120 mm) Thermoplastic Enclosure (Transparent Deep Cover)

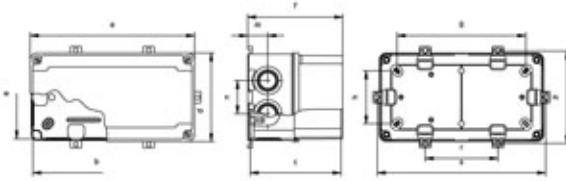

a	b	c	d	e	f	g	h	m	n	p	r	s
110	210	120	117	217	185.5	170	70	26.5	44	122	2	202

Parça No. / Part No.	Malzeme Material	Conta Seal	Rakor girişi Gland entry	Renk / Color	IP
402022-07	ABS	+	+	Gri / Gray (Ral 7035)	67
402022-07ce	PS	+	+	Gri / Gray (Ral 7038)	67
402022-27	ABS HF V2	+	+	Krem / Ivory (Ral 9016)	67
40202201-07	ABS	+	-	Gri / Gray (Ral 7035)	67
40202201-07ce	PS	+	-	Gri / Gray (Ral 7038)	67
40202201-27	ABS HF V2	+	-	Krem / Ivory (Ral 9016)	67
402022-07e	PS	-	+	Gri / Gray (Ral 7038)	54
40202201-07e	PS	-	-	Gri / Gray (Ral 7038)	54

Amb. /Adet
Packing/Pcs. **24**

TERMOPLASTİK BUAT (Derin Şeffaf Kapak) (140 x 210 x 140 mm) Thermoplastic Enclosure (Transparent Deep Cover)

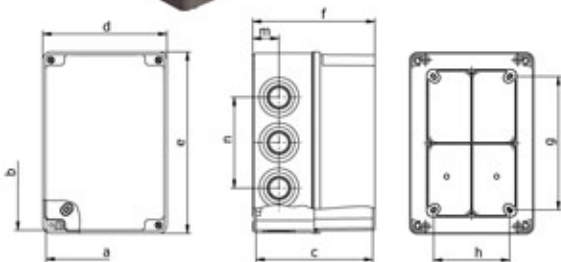

a	b	c	d	e	f	g	h	m	n
140	210	140	149	218	146.5	160	91	31.5	109

Parça No. / Part No.	Malzeme Material	Conta Seal	Rakor girişi Gland entry	Renk / Color	IP
402042-07	ABS	+	+	Gri / Gray (Ral 7035)	67
402042-07ce	PS	+	+	Gri / Gray (Ral 7038)	67
402042-27	ABS HF V2	+	+	Krem / Ivory (Ral 9016)	67
40204201-07	ABS	+	-	Gri / Gray (Ral 7035)	67
40204201-07ce	PS	+	-	Gri / Gray (Ral 7038)	67
40204201-27	ABS HF V2	+	-	Krem / Ivory (Ral 9016)	67
402042-07e	PS	-	+	Gri / Gray (Ral 7038)	54
40204201-07e	PS	-	-	Gri / Gray (Ral 7038)	54

Amb. /Adet
Packing/Pcs. **15**

TERMOPLASTİK BUAT (Derin Şeffaf Kapak) (210 x 210 x 140 mm) Thermoplastic Enclosure (Transparent Deep Cover)

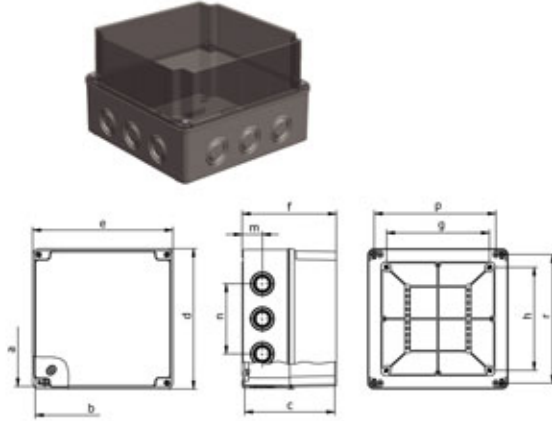

a	b	c	d	e	f	g	h	m	n	p	r
210	210	140	218	218	146.5	160	160	31.5	109	180	200

Parça No. / Part No.	Malzeme Material	Conta Seal	Rakor girişi Gland entry	Renk / Color	IP
402052-07	ABS	+	+	Gri / Gray (Ral 7035)	67
402052-07ce	PS	+	+	Gri / Gray (Ral 7038)	67
402052-27	ABS HF V2	+	+	Krem / Ivory (Ral 9016)	67
40205201-07	ABS	+	-	Gri / Gray (Ral 7035)	67
40205201-07ce	PS	+	-	Gri / Gray (Ral 7038)	67
40205201-27	ABS HF V2	+	-	Krem / Ivory (Ral 9016)	67
402052-07e	PS	-	+	Gri / Gray (Ral 7038)	54
40205201-07e	PS	-	-	Gri / Gray (Ral 7038)	54

Amb. /Adet
Packing/Pcs. 10

TERMOPLASTİK BUAT (Derin Şeffaf Kapak) (190 x 240 x 160 mm) Thermoplastic Enclosure (Transparent Deep Cover)

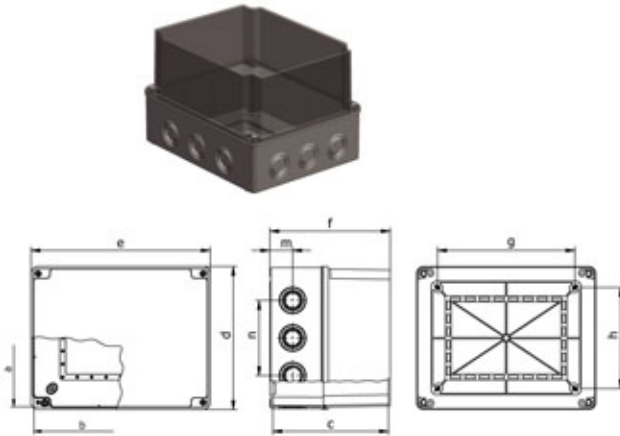

a	b	c	d	e	f	g	h	m	n
190	240	160	198	248	166.5	190	140	31.5	104

Parça No. / Part No.	Malzeme Material	Conta Seal	Rakor girişi Gland entry	Renk / Color	IP
402082-07	ABS	+	+	Gri / Gray (Ral 7035)	67
402082-07ce	PS	+	+	Gri / Gray (Ral 7038)	67
402082-27	ABS HF V2	+	+	Krem / Ivory (Ral 9016)	67
40208201-07	ABS	+	-	Gri / Gray (Ral 7035)	67
40208201-07ce	PS	+	-	Gri / Gray (Ral 7038)	67
40208201-27	ABS HF V2	+	-	Krem / Ivory (Ral 9016)	67
402082-07e	PS	-	+	Gri / Gray (Ral 7038)	54
40208201-07e	PS	-	-	Gri / Gray (Ral 7038)	54

Amb. /Adet
Packing/Pcs. 10

TERMOPLASTİK BUAT (Derin Şeffaf Kapak) (210 x 290 x 140 mm) Thermoplastic Enclosure (Transparent Deep Cover)

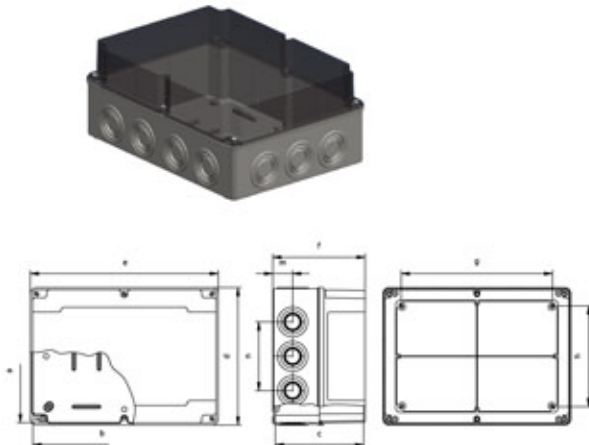

a	b	c	d	e	f	g	h	m	n
210	290	140	218	298	146.5	240	180	31.5	109

Parça No. / Part No.	Malzeme Material	Conta Seal	Rakor girişi Gland entry	Renk / Color	IP
402032-07	ABS	+	+	Gri / Gray (Ral 7035)	67
402032-07ce	PS	+	+	Gri / Gray (Ral 7038)	67
402032-27	ABS HF V2	+	+	Krem / Ivory (Ral 9016)	67
40203201-07	ABS	+	-	Gri / Gray (Ral 7035)	67
40203201-07ce	PS	+	-	Gri / Gray (Ral 7038)	67
40203201-27	ABS HF V2	+	-	Krem / Ivory (Ral 9016)	67
402032-07e	PS	-	+	Gri / Gray (Ral 7038)	54
40203201-07e	PS	-	-	Gri / Gray (Ral 7038)	54

Amb. /Adet
Packing/Pcs. 6

TERMOPLASTİK BUAT (Derin Şeffaf Kapak) (290 x 290 x 140 mm) Thermoplastic Enclosure (Transparent Deep Cover)

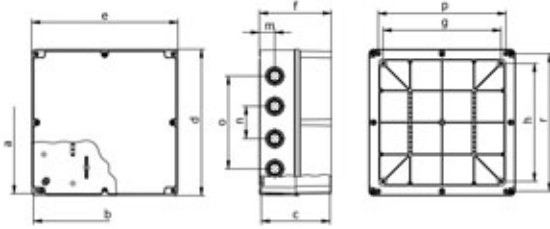

Parça No. / Part No.	Malzeme Material	Conta Seal	Rakor girişi Gland entry	Renk / Color	IP
402072-07	ABS	+	+	Gri / Gray (Ral 7035)	67
402072-07ce	PS	+	+	Gri / Gray (Ral 7038)	67
402072-27	ABS HF V2	+	+	Krem / Ivory (Ral 9016)	67
40207201-07	ABS	+	-	Gri / Gray (Ral 7035)	67
40207201-07ce	PS	+	-	Gri / Gray (Ral 7038)	67
40207201-27	ABS HF V2	+	-	Krem / Ivory (Ral 9016)	67
402072-07e	PS	-	+	Gri / Gray (Ral 7038)	54
40207201-07e	PS	-	-	Gri / Gray (Ral 7038)	54

a	b	c	d	e	f	g	h	m	n	o	p	r
290	290	140	298	298	146.5	240	240	31.5	66	189	260	280

Amb. /Adet
Packing/Pcs. **4**

YATAY KLEMENS KUTUSU (Derin Kapak) (110 x 210 x 120 mm)
Thermoplastic Enclosure for Terminal (Deep Cover)

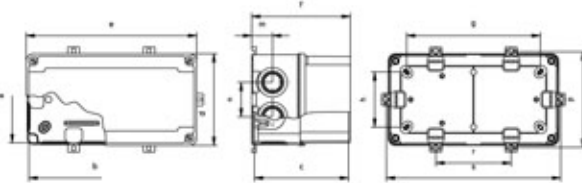

Parça No. / Part No.	Malzeme Material	Conta Seal	Rakor girişi Gland entry	Renk / Color	IP
402023-05	ABS	+	+	Gri / Gray (Ral 7035)	67
402023-05ce	PS	+	+	Gri / Gray (Ral 7038)	67
402023-02	ABS HF V2	+	+	Krem / Ivory (Ral 9016)	67
40202301-05	ABS	+	-	Gri / Gray (Ral 7035)	67
40202301-05ce	PS	+	-	Gri / Gray (Ral 7038)	67
40202301-02	ABS HF V2	+	-	Krem / Ivory (Ral 9016)	67
402023-05e	PS	-	+	Gri / Gray (Ral 7038)	54
40202301-05e	PS	-	-	Gri / Gray (Ral 7038)	54

a	b	c	d	e	f	g	h	m	n	o	p	r
110	210	120	117	117	125.5	170	70	26.5	44	112	16	212

Amb. /Adet
Packing/Pcs. **24**

YATAY KLEMENS KUTUSU (Derin Kapak) (210 x 290 x 140 mm)
Thermoplastic Enclosure for Terminal (Deep Cover)

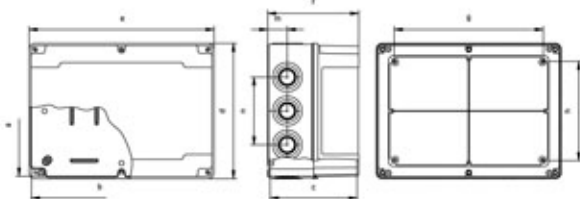

Parça No. / Part No.	Malzeme Material	Conta Seal	Rakor girişi Gland entry	Renk / Color	IP
402036-05	ABS	+	+	Gri / Gray (Ral 7035)	67
402036-05ce	PS	+	+	Gri / Gray (Ral 7038)	67
402036-02	ABS HF V2	+	+	Krem / Ivory (Ral 9016)	67
40203601-05	ABS	+	-	Gri / Gray (Ral 7035)	67
40203601-05ce	PS	+	-	Gri / Gray (Ral 7038)	67
40203601-02	ABS HF V2	+	-	Krem / Ivory (Ral 9016)	67
402036-05e	PS	-	+	Gri / Gray (Ral 7038)	54
40203601-05e	PS	-	-	Gri / Gray (Ral 7038)	54

a	b	c	d	e	f	g	h	m	n
210	290	140	218	218	146.5	240	100	31.5	109

Amb. /Adet
Packing/Pcs. **6**

YATAY KLEMENS KUTUSU (Derin Şeffaf Kapak) (110 x 210 x 120 mm)
Thermoplastic Enclosure for Terminal (Transparent Deep Cover)

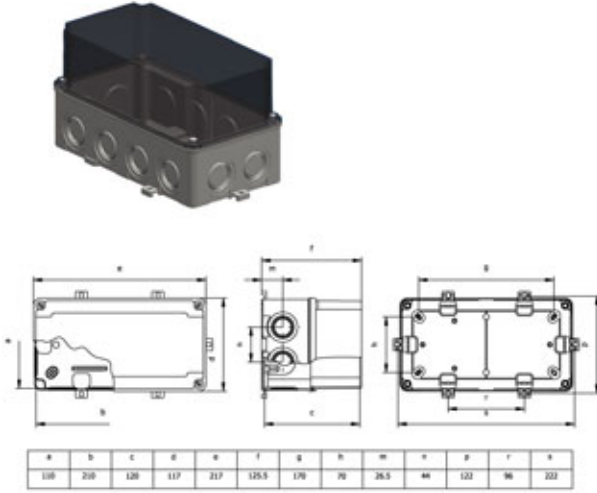

Parça No. / Part No.	Malzeme Material	Conta Seal	Rakor girişi Gland entry	Renk / Color	IP
402023-07	ABS	+	+	Gri / Gray (Ral 7035)	67
402023-07ce	PS	+	+	Gri / Gray (Ral 7038)	67
402023-27	ABS HF V2	+	+	Krem / Ivory (Ral 9016)	67
40202301-07	ABS	+	-	Gri / Gray (Ral 7035)	67
40202301-07ce	PS	+	-	Gri / Gray (Ral 7038)	67
40202301-27	ABS HF V2	+	-	Krem / Ivory (Ral 9016)	67
402023-07e	PS	-	+	Gri / Gray (Ral 7038)	54
40202301-07e	PS	-	-	Gri / Gray (Ral 7038)	54

Amb. /Adet Packing/Pcs. **24**

YATAY KLEMENS KUTUSU (Derin Şeffaf Kapak) (210 x 290 x 140 mm)
Thermoplastic Enclosure for Terminal (Transparent Deep Cover)

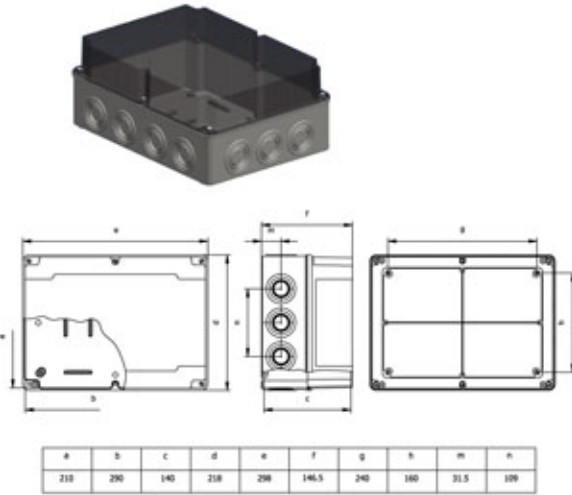

Parça No. / Part No.	Malzeme Material	Conta Seal	Rakor girişi Gland entry	Renk / Color	IP
402036-07	ABS	+	+	Gri / Gray (Ral 7035)	67
402036-07ce	PS	+	+	Gri / Gray (Ral 7038)	67
402036-27	ABS HF V2	+	+	Krem / Ivory (Ral 9016)	67
40203601-07	ABS	+	-	Gri / Gray (Ral 7035)	67
40203601-07ce	PS	+	-	Gri / Gray (Ral 7038)	67
40203601-27	ABS HF V2	+	-	Krem / Ivory (Ral 9016)	67
402036-07e	PS	-	+	Gri / Gray (Ral 7038)	54
40203601-07e	PS	-	-	Gri / Gray (Ral 7038)	54

Amb. /Adet Packing/Pcs. **6**



IP 65

3964 (Halogen Free, V2) Gri / Gray
SİGORTA MODÜLÜ (13'lü)
(180 x 330 x 150 mm)
Fuse Enclosure

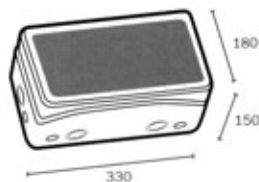

Amb. /Adet Packing/Pcs. **12**



IP 65

3965 (Halogen Free, V2) Gri / Gray
SİGORTA MODÜLÜ (2 x 3'lü)
(180 x 330 x 150 mm)
Fuse Enclosure



Amb. /Adet Packing/Pcs. **12**

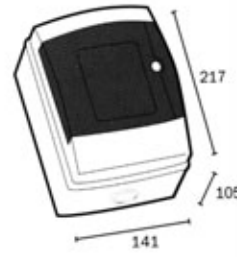

IP 65

3904-T (Halogen Free, V2) Gri / Gray
4'LÜ SİGORTA KUTUSU (217 x 141 x 105 mm) 4 Way Unit With Transparent Cover

Amb. /Adet
Packing/Pcs. 32

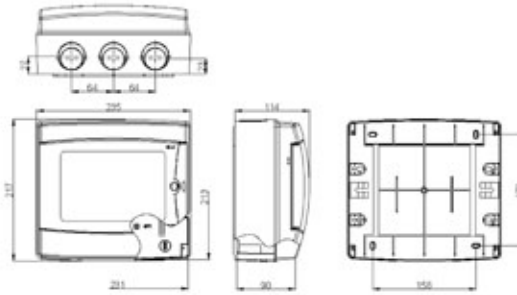

IP 65

3908-T (Halogen Free, V2) Gri / Gray
8'Lİ SİGORTA KUTUSU (235 x 217 x 105 mm) 8 Way Unit With Transparent Cover

Amb. /Adet
Packing/Pcs. 16

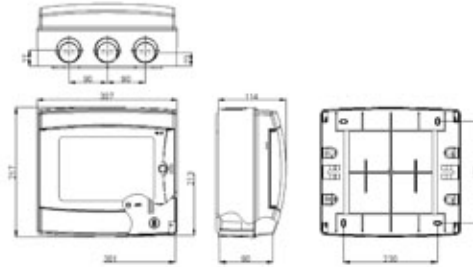

IP 65

3912-T (Halogen Free, V2) Gri / Gray
12'Lİ SİGORTA KUTUSU (307 x 217 x 105 mm) 12 Way Unit With Transparent Cover

Amb. /Adet
Packing/Pcs. 12

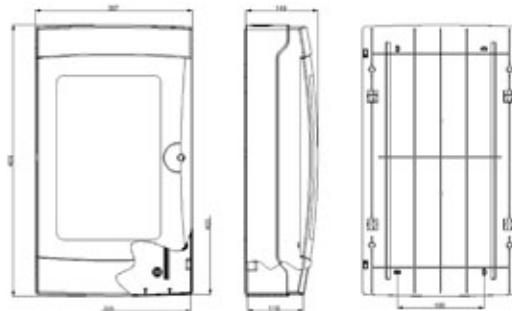

IP 65

3926-T (Halogen Free, V2) Gri / Gray
26'Lİ SİGORTA KUTUSU (307 x 409 x 115 mm) 26 Way Unit With Transparent Cover

Amb. /Adet
Packing/Pcs. 5

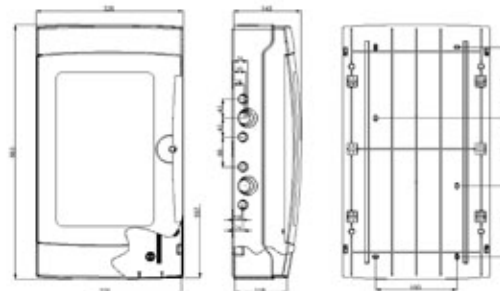

IP 65

3942-T (Halogen Free, V2) Gri / Gray
42'Lİ SİGORTA KUTUSU (326 x 563 x 150 mm) 42 Way Unit With Transparent Cover

Amb. /Adet
Packing/Pcs. 4

SİGORTA MODÜLÜ (10'lu) (140 x 210 x 114 mm) Fuse Enclosure

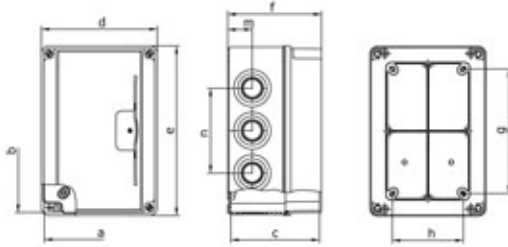

a	b	c	d	e	f	g	h	m	n
140	210	114	149	218	120	160	91	31.5	109

Parça No. / Part No.	Malzeme Material	Conta Seal	Rakor girişi Gland entry	Renk / Color	IP
402045-05	ABS	+	+	Gri / Gray (Ral 7035)	66
402045-05ce	PS	+	+	Gri / Gray (Ral 7038)	66
402045-02	ABS HF V2	+	+	Krem / Ivory (Ral 9016)	66
40204501-05	ABS	+	-	Gri / Gray (Ral 7035)	66
40204501-05ce	PS	+	-	Gri / Gray (Ral 7038)	66
40204501-02	ABS HF V2	+	-	Krem / Ivory (Ral 9016)	66
402045-05e	PS	-	+	Gri / Gray (Ral 7038)	54
40204501-05e	PS	-	-	Gri / Gray (Ral 7038)	54

Amb. /Adet Packing/Pcs. 20

SİGORTA MODÜLÜ (2 x 10'lu) (210 x 290 x 114 mm) Fuse Enclosure

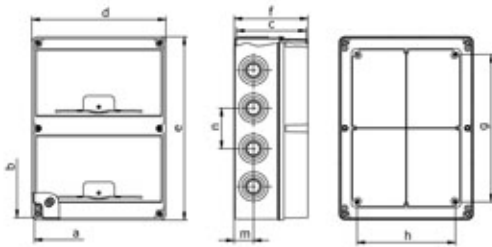

a	b	c	d	e	f	g	h	m	n
210	290	114	218	298	120	240	160	31.5	66

Parça No. / Part No.	Malzeme Material	Conta Seal	Rakor girişi Gland entry	Renk / Color	IP
402055-05	ABS	+	+	Gri / Gray (Ral 7035)	66
402055-05ce	PS	+	+	Gri / Gray (Ral 7038)	66
402055-02	ABS HF V2	+	+	Krem / Ivory (Ral 9016)	66
40205501-05	ABS	+	-	Gri / Gray (Ral 7035)	66
40205501-05ce	PS	+	-	Gri / Gray (Ral 7038)	66
40205501-02	ABS HF V2	+	-	Krem / Ivory (Ral 9016)	66
402055-05e	PS	-	+	Gri / Gray (Ral 7038)	54
40205501-05e	PS	-	-	Gri / Gray (Ral 7038)	54

Amb. /Adet Packing/Pcs. 8

SİGORTA MODÜLÜ (14'lü) (210 x 290 x 114 mm) Fuse Enclosure

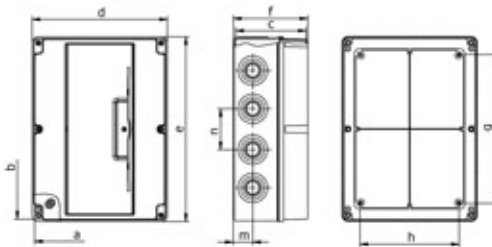

a	b	c	d	e	f	g	h	m	n
210	290	140	218	298	146.5	240	160	31.5	66

Parça No. / Part No.	Malzeme Material	Conta Seal	Rakor girişi Gland entry	Renk / Color	IP
402060-05	ABS	+	+	Gri / Gray (Ral 7035)	66
402060-05ce	PS	+	+	Gri / Gray (Ral 7038)	66
402060-02	ABS HF V2	+	+	Krem / Ivory (Ral 9016)	66
40206001-05	ABS	+	-	Gri / Gray (Ral 7035)	66
40206001-05ce	PS	+	-	Gri / Gray (Ral 7038)	66
40206001-02	ABS HF V2	+	-	Krem / Ivory (Ral 9016)	66
402036-05e	PS	-	+	Gri / Gray (Ral 7038)	54
40203601-05e	PS	-	-	Gri / Gray (Ral 7038)	54

Amb. /Adet Packing/Pcs. 6



20196

GEÇMELİ KANAL ADAPTÖRÜ

Cable Gland for Cable Trunking Systems

16x16, 16x25, 25x25, 25x40 mm Kanallar ve 90x90x50 Termoplastik Buat için
For 16x16, 16x25, 25x25, 25x40 mm Dimensions and 90x90x50 mm Enclosure



RG - 5

2 x 16 mm² + 5 x 10 mm²

RG - 12

2 x 16 mm² + 12 x 10 mm²

RG - 5 - RG - 12

NÖTR VE TOPRAKLAMA BARASI Neutral and Earth Terminal Bar



SPTA - 12

NÖTR VE TOPRAKLAMA KLEMENSİ (2 x 16 mm² + 12 x 10 mm²) Neutral and Earth Terminal Bar



3400 - B

KAPAK (9'lu) Blind Cover



3903

EK PARÇASI (M 40) Joint Part



20058

EK PARÇASI (Pg 29) Joint Part

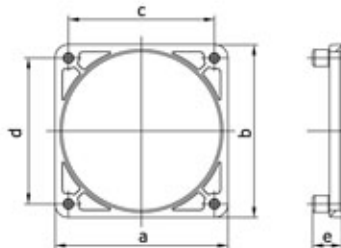

KOD NO	a	b	c	d	e
20013	47	47	38	38	10
20040	73	73	60	60	10
20041	83	83	70	70	10

20013 / 20040 / 20041 MONTAJ ADAPTÖRLERİ Fixing Adaptors

Standart Metal Rakor	Kademeli Rakor	Plastik Kablo Rakoru	Metal Kablo Rakoru	Spiral Kablo Rakoru
<i>Standard Metal Cable Gland</i>	<i>Cable Gland</i>	<i>Plastic Cable Gland</i>	<i>Metal Cable Gland</i>	<i>Cable Gland for Plastic Conduit</i>

IP 65

IP 55

IP 68

IP 68

IP 54



PG 7

PG 9

PG 11

PG 13.5

PG 16

PG 21

PG 29

PG 36

PG 42

PG 48

29950

29952 / 29953

29954

20054

20055

20056

50101

50102

50103

50104

50105

50106

50107

50108

50109

50110

50201

50202

50203

50204

50205

50206

50207

50208

50209

50210

50301

50302

50303

50304

50305

50306

50307

50308

50309

50310

M 12x1.5

M 16x1.5

M 20x1.5

M 25x1.5

M 32x1.5

M 40x1.5

M 50x1.5

M 63x1.5

50502

50503

50504

50505

50506

50507

50508

50509

50602

50603

50604

50605

50606

50607

50608

50609

IP SINIFLANDIRMASINA GÖRE KORUMA DERECELERİ









IP PROTECTION DEGREES

(CEI 529, DIN 400 50, BS 5490 ve NF C 20 - 010)

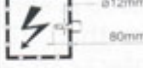
1. rakam : Yabancı maddelerin girişine ve temasa karşı koruma
1st Number : Protection against entry of solid bodies and contact

2. rakam : Suya karşı koruma
2nd Number : Protection against water penetration

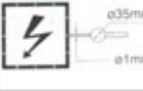
AÇIKLAMA / Description

Code	Yabancı maddelere Karşı Koruma Protection Against Entry of Solid Bodies	Test	Temasa Karşı Koruma Protection Against Contact With	Test
0	Korumasız / No Protection			
1	50 mm'den büyük Larger than 50 mm		Elin tersi Back of Hand	
2	12,5 mm'den büyük Larger than 12,5 mm		Deney parmağı Test Finger	
3	2,5 mm'den büyük Larger than 2,5 mm		El aletleri (tornavida vb.) Small tools	
4	1 mm'den büyük Larger than 1 mm		Kablo Wire	
5	Zararlı miktarda toza karşı koruma Dust in harmful quantities			
6	Toza karşı tam koruma Total protection against dust			

AÇIKLAMA / Description

Code	Suya Karşı Koruma Protection Against Water Penetration	Test
0	Korumasız / No Protection	
1	Dikey su damllarına karşı koruma Drop of water falling vertically	
2	15°'ye kadar açılı su damllarına karşı koruma Drop of water falling with an angle up to 15°	
3	60°'ye kadar açılı su püskürtmeye karşı koruma Water spray with an angle up to 60°	
4	Her yönden su püskürtmeye karşı koruma Splash water from all directions	
5	Her yönden basınçla püskürtülen suya karşı koruma Water jets from all directions	
6	Dalgta etkisindeki suya karşı koruma Water surge protection	
7	Geçici bir süre suyun altında kalma Temporary immersion	
8	Sürekli suyun altında kalma Continuous immersion	Üretici ve tüketicinin anlaştığı şekilde As agreed by customer & manufacturer

NOT: IP ve IK işaretleri (→) Elektrik malzemelerinin dış kaplayıcıların koruma derecesidir. (Bu koruma dereceleri sertifikalı laboratuvarlar tarafından yapılan testler sonucunda belirlenir.)

Mekanik darbelere karşı koruma (IK)

NF EN 50102 (NFC 20 - 015) Normunun 1 nolu ekine göre

Degree of protection against mechanical impacts

IK in accordance with standart NF EN 50102 (NFC 20 - 015)

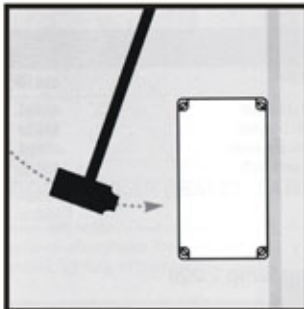

IK code	Impact energy	IK code	Impact energy
00	Korumasız / No protection	06	1 joule
01	0,15 joule	07	2 joule
02	0,2 joule	08	5 joule
03	0,35 joule	09	10 joule
04	0,5 joule	10	20 joule
05	0,7 joule		